



Robomow®

Operating & Safety Manual

RM510 & Base Station



Download Courtesy of Probotics.com

www.robomow.eu / www.robomow.com

DOC5002E

Robomow®

The products are manufactured by F. Robotics Acquisitions (Friendly Robotics).

Friendly Robotics products are CE approved.



Friendly Robotics products comply with the requirements of the RoHS (Restrictions on Hazardous Substances) Directive 2002/95/EC and the WEEE (Waste Electrical and Electronic Equipment) Directive 2002/96/EC.



© **Friendly Robotics, 2012-A.** All rights reserved. No part of this document may be photocopied, reproduced, electronically or translated without the prior written consent of Friendly Robotics.

Product, product specifications and this document are subject to change without notice. All other trademarks are property of their respective owners.

Welcome to the world of home robotics with the Friendly Robotics Robomow!

Thank you for purchasing our product. We know that you will enjoy the extra free time you will have while using Robomow to mow your lawn. When set up and used properly, Robomow will operate safely on your lawn and provide you with a quality of cut matched by a few mowers of any kind. You will be impressed with your lawn's appearance and best of all, Robomow did it for you.

IMPORTANT!

**The following pages contain important safety and operating instructions.
Please read and follow all instructions in this manual. Carefully read and review all safety instructions, warnings and cautions contained in this manual.
Failure to read and follow these instructions, warnings and cautionary statements may result in severe injury or death to persons and pets or damage to personal property.**

Table of Contents

| | |
|--|----|
| Safety Warnings & Precautions | 4 |
| Warnings Decal Definitions | 6 |
| Robomow® Safety Features | 7 |
| How It Works | 9 |
| What's in the Box | 10 |
| Chapter 1 - Base Station & Perimeter Wire Setup | 11 |
| 1.1 Preparations..... | 11 |
| 1.2 Planning the Setup..... | 11 |
| 1.3 Location of the Base Station..... | 16 |
| 1.4 Perimeter Wire Setup..... | 17 |
| 1.5 Robomow Preparation and Settings..... | 21 |
| 1.6 Testing The Base Station and Perimeter Wire Position..... | 24 |
| 1.7 Setup in None-Base Zone..... | 25 |
| Chapter 2 – Menu | 28 |
| 2.1 Zones Setup..... | 29 |
| 2.1.1 Set Zone: Base..... | 29 |
| 2.1.2 Set Zone: A or (B)..... | 34 |
| 2.2 Settings..... | 36 |
| 2.3 Information..... | 38 |
| Chapter 3 – Operation | 40 |
| 3.1 Edge Mowing | 40 |
| 3.2 Scanning (Mowing of the inner area)..... | 40 |
| 3.3 Skipping Edge Mowing | 40 |
| 3.4 Operation in Base Zone – Automatic Start | 40 |
| 3.5 Operation in Base Zone – Manual Start | 41 |
| 3.6 Returning to the Base Station | 41 |
| 3.7 Operation in None-Base Zone | 41 |
| 3.8 Completing the Operation | 41 |
| 3.9 Charging | 42 |
| Chapter 4 – Text Messages and Troubleshooting | 43 |
| 4.1 Messaging..... | 43 |
| 4.2 Other Operational or Fault Problems..... | 48 |
| Chapter 5 – Maintenance and Storage | 50 |
| 5.1 Recommended Maintenance Schedule | 50 |
| 5.2 Cleaning..... | 50 |
| 5.3 Battery..... | 50 |
| 5.4 Base Station..... | 51 |
| 5.5 Replacing the Blade | 51 |
| 5.6 Splicing the Perimeter Wire | 52 |
| 5.7 Winter Storage..... | 52 |
| 5.8 Batteries Replacement..... | 53 |
| Chapter 6 – Specifications | 54 |
| Chapter 7 – Accessories | 55 |
| Tips for maintaining your lawn | 56 |
| Friendly Robotics RM Series Limited Warranty | 57 |
| EU Declaration of Conformity | 58 |

Safety Warnings & Precautions

Training and Instructions

1. Read this manual carefully before operating Robomow®. Be familiar with the controls and the proper use of Robomow® and follow all safety and warning instructions.
2. Do not use Robomow® for any purpose other than for which it is intended.
3. Never allow children or people unfamiliar with these instructions to operate Robomow®.
4. Never mow while people, especially children, or pets are nearby.
5. The user is responsible for accidents or hazards occurring to other people or their property.
6. It is strongly recommended to use the '**Child Guard**' or '**Anti theft**' menu option in order to prevent operation by children or other who are not familiar with the safe operation of the mower
7. The appliance is not to be used by children or persons with reduced physical, sensory or mental capabilities, or lack of experience and knowledge, unless they have been given supervision or instruction. Children should be supervised to ensure they do not play with the appliance.
8. Warning! When there is a risk of lightning storm, disconnect the perimeter wire from the Base Station/ Perimeter Switch and the Power Supply 230V/120V plug from the mains socket

Preparation

9. Make sure to layout and set up the perimeter wire according to the instructions.
10. While mowing using a Remote Control always wear substantial footwear and long trousers.
11. Periodically inspect the area mowed by Robomow®, and remove stones, sticks, wires, bones and other objects. Objects struck by the blade may be thrown and cause severe injuries to people.
12. Only use accessories and attachments designed for this product.

Operation

13. Never let Robomow operate without supervision.
14. When using the Remote Control mow only in daylight or in a good artificial light.
15. Do not operate Robomow® using the Remote Control when barefoot or wearing open sandals. Always wear substantial footwear and long trousers.
16. Avoid operating Robomow® on wet grass. Do not use it in rain.
17. When using Remote Control always be sure of your footing on slopes.
18. Do not operate the mower on slopes greater than 18 degrees.
19. Keep all guards, shields, safety devices, and sensors in place. Repair or replace damaged parts, including decals. Do not operate Robomow® if any parts are damaged or worn.
20. Do not operate Robomow® if any safety feature or device is damaged or inoperable.
21. Do not attempt to disable or defeat any safety feature or device.
22. When using the Remote Control always switch on the motor according to instructions and with feet well away from the blade.
23. This machine has sharp rotating blade! Never operate the mower if unattended; keep bystanders, children and pets away from mower when in operation.
24. Never allow anyone to ride or sit on mower.
25. Keep hands and feet away from the cutting blade and other moving parts.
26. Never pick up or carry this appliance while the motors are running.
27. Never attempt to service or adjust the mower while it is in operation.
28. Never raise the mower or attempt to inspect the blade while the mower is operating.
29. Always remove the fuse before lifting the mower or attempting any adjustments.

Base Station

30. Never let Robomow operate without supervision.
31. When programming the automatic start times and days, insure these windows of operation are programmed when children, pets and other bystanders are not on the lawn.
32. Do not place metal objects in the area of the Base Station contacts.
33. After removing the fuse from the mower always reset the current time and date. Failure to do so may result in non-intentional operation of the Robomow, which may cause sever bodily injuries.
34. Do not spray water directly into the Base Station area.

Transport

To safely move from or within the working area:

35. Use the Remote Control (available as an accessory) to drive it from place to place (See section 2.4).
36. In case of different height level or stairs, turn off the mower by pressing the Main Switch button, lift the bumper door, located at the top of the Robomow, and carry the mower by the carrying handle, while the rear bottom side is laying on your thigh, as shown in the right figure.
37. In case of long transportation by car it is required to remove the fuse and use the original packaging.



Maintenance and storage

38. Maintain, service, and store Robomow[®] according to the instructions (refer to chapter 5).
39. Remove the battery fuse before working on or lifting Robomow. Remove the battery fuse before any maintenance is done.
40. Keep all nuts, bolts, and screws tight to assure safe condition of this appliance.
41. Replace worn or damaged parts for safety.
42. Use heavy gloves when inspecting, servicing or replacing the blade.
43. Use only the original equipment, batteries and power supply/charger with this mower. Incorrect use may result in electric shock, overheating or leakage of corrosive liquid from the battery.
44. Do not open or mutilate the battery. Released electrolyte is corrosive and may damage the eyes or skin.
45. Wear eye protection and use gloves when setting the perimeter wire and driving the wire stakes/pegs. Firmly drive all pegs in order to keep the wire from becoming a tripping hazard.
46. Do not use the power supply/charger if the cord has damaged.
47. A spark may be created when inserting the fuse to the robot. Therefore it is forbidden to perform these tasks close to flammable materials. It is also forbidden to use spray or any other cleaning materials for cleaning electronic contacts, due to this risk of inflammation when inserting the power pack or fuse.

Product end of use

48. Robomow and its accessories should be collected separately at the end of their life to prevent waste electrical and electronic equipment from ending up in landfill sites, to promote the reuse, treatment and recovery of electrical and electronic equipment in purpose to preserve, protect and improve the quality of the environment, protect human health and utilize natural resources prudently and rationally.
49. Do not dispose Robomow or any other part of it (including the Charger, Base Station and Perimeter Switch) as unsorted municipal waste – it should be collected separately.
50. Ask your local distributor/dealer about return and collection systems available.
51. Do not dispose of the batteries in a fire and do not place used batteries in your household trash. The batteries must be collected, recycled, or disposed of in an environmentally sound manner.

Warnings Decal Definitions

These are the symbols on Robomow®; Read them carefully before operating Robomow®.

DANGER! Sharp rotating blade. Keep hands and feet away. Serious injury can occur. Caution – Do not touch rotating blade



1 2 3 4 5 6 7

1. Safety alerts symbol – WARNING - **this is a dangerous power tool. Use care when operating and follow all safety instructions and warnings.**
2. Read operator's manual – **Read user instructions before operating your Robomow®**
3. Hazard of Thrown or flying objects - **Whole body exposure, take caution.**
4. Keep a safe distance from the machine when operating
Keep people in particular children, pets and bystanders away from the area in which Robomow is being used.
5. Severing of toes or fingers - Rotary mower blade
Risk of injury from rotating cutting blade. Keep hands and feet away and do not attempt to lift Robomow from this area.
6. Remove the Fuse before working on or lifting Robomow®.
7. **Do not ride on Robomow®.**

Disposal of old Electrical & Electronic Equipment

Do not dispose Robomow® or any other part of it as unsorted municipal waste – instead it shall be handed over to the applicable collection point for the recycling of electrical and electronic equipment.



EC Conformity

This product conforms to the applicable EU Directives



Robomow[®] Safety Features

1. Child Guard / Safety Guard (Level I)

This menu option offers a safety feature to help prevent children or others not familiar with the safe operation of the mower to operate it freely.

2. Anti-Theft / Safety Guard (level II)

The anti-theft system provides the user a disabling function that will prevent anyone from using or driving the Robomow unless they have the valid code to enter. You will be prompted to enter a four-digit code of your choice to use as your personal security code.

3. Lift Sensor

There is a Hall-Effect Sensor (Magnetic Position Sensor) located in the front side of Robomow. In case the front of the mower is raised approximately 1-inch from its resting position on the ground during blade operation, the blade will immediately stop rotating (< 1 second).

4. Tilt Sensor

There is an optical sensor located in the front side of Robomow. In case the front of the mower is lifted up towards a vertically position, the blade will stop immediately and Robomow will warn about it and instruct the user to remove the fuse before lifting Robomow.

5. Bumper Sensor

The bumper is equipped with Hall Effect sensor activates when the mower strikes a solid, fixed object and when the bumper cover is open. When the bumper sensor is activated, the mower will stop the rotation of the blade immediately (<1 second), will stop movement in that direction and reverse itself away from the obstacle.

6. Emergency Stop Button

Located on the control panel, red in color. Pressing this button at any time during operation will stop all mower movement and stop the rotation of the blade immediately (<1 second).

7. Batteries Fuse

Located below the bumper cover, on the left side of Robomow. Removing the battery fuse will prevent any operation of the Robomow. It is required to remove the fuse before lifting Robomow and before any maintenance is done.

8. Two-Step Operator Presence Control

While in manual mode using the remote control, it requires two independent finger actions in order to engage the mower blade. Once engaged, the mower blade button must remain depressed to continue blade operation. Once released, the two-step engagement process must be repeated.

9. Electronically Controlled Charging System

Robomow is equipped with an on-board charge control system. This allows you to keep the charger connected at all times, even after the battery is fully charged. The control system will prevent an overcharge to the battery and keep it fully charged and maintained for the next use.

10. Sealed Batteries

The batteries that operate the Robomow are completely sealed and will not leak any type of fluids, regardless of position. In addition, the batteries contain a one-time-use fuse in the event of a short-circuit or power malfunction.

11. Base Station/Perimeter Switch and Perimeter Wire

Robomow cannot operate without a perimeter wire installed and activated through the Base Station/Perimeter Switch. In the event the Base Station/Perimeter Switch is turned off or otherwise fails to function, Robomow will stop operating. Likewise, should a break in the perimeter wire occur Robomow will again stop operation. A break in the perimeter wire prior to operation will prevent Robomow from operating. It can only operate within the boundary of the perimeter wire.

12. Automatic warning alert before operation

When the mower is scheduled to start the automatic operation from the Base Station per a scheduled time, a warning buzzer and the operating lamp will activate 5 minutes prior to operation. This is a warning notification to clear and inspect the area.

13. Over-heat Monitoring Protection

The blade motor and each of the two wheel drive motors are monitored continuously during operation for any situation that may cause these motors to over-heat. In such event, Robomow will stop operation of at least that motor and possibly the mower itself and indicate that the motor is cooling down. While unusual, this may happen when the mower is on grass that is severely overgrown; the underside of the mower is clogged from poor cleaning maintenance; the mower has encountered an obstacle that is unable to activate the bumper sensor preventing it from moving; or a problem landscape area has caused the mower to get stuck and is preventing it from moving.

WARNING!



This warning symbol will be found at several points throughout the pages of this manual. It is intended to highlight an important safety, warning or cautionary message. Please pay particular attention to these areas and be sure you fully understand the message before proceeding.

How It Works

- A one-time setup is required before operating the Robomow; a small wire, called the **perimeter wire**, is placed around the edge of the lawn and any other areas where you do not want the mower to enter.
- **Small pegs** are supplied with the Robomow and they are used to fasten and hold the perimeter wire to the ground, below grass level; the wire will soon disappear under the growth of new grass and will not be visible.
- The **Base Station** is placed along the perimeter wire and it has two main functions:
 - To generate a small signal along the perimeter wire (very low voltage);
 - To charge the Robomow batteries.
- After completing the one-time set-up of wire around the lawn including the Base Station, set the **weekly program** and forget about mowing for the entire season!
- Robomow will leave the Base Station on the day and time scheduled in the automatic weekly program; it will mow the lawn and will drive back for charging in the Base Station to be ready for the next operation.
- When Robomow leaves the Base Station it automatically starts the **signal** carried through the Base Station; the signal creates a **virtual wall**, which is visible only to the Robomow, keeping the Robomow inside the lawn preventing it to cross over area where you do not want it to enter.

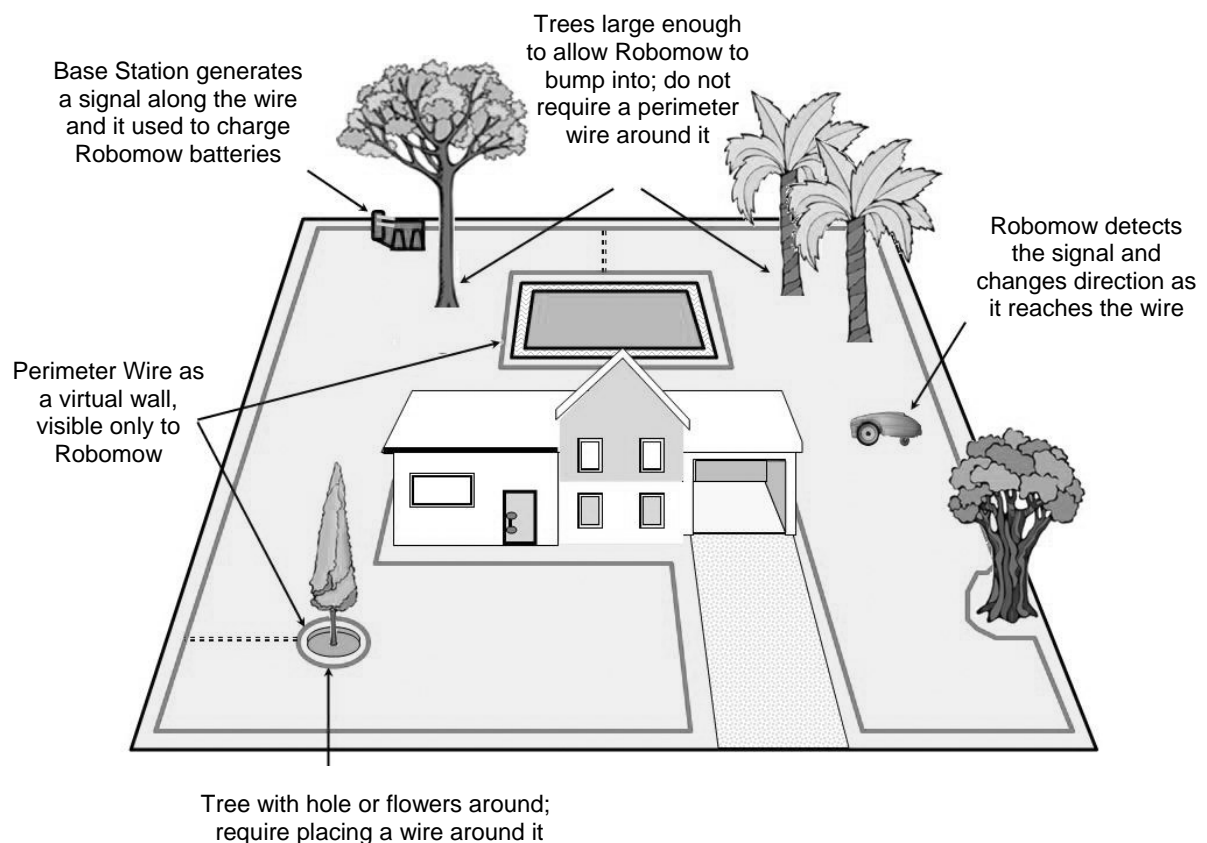

Robomow[®]
It mows. You don't.sm

What's in the Box

Open the box and lift the Robomow from its carrying handle; Robomow and the Base Station are bound together with two strips; cut the strips and pull back the Robomow from the Base Station.

Robomow®



Base Station



Base Station Stakes

Power Supply



Wire

Pegs



Plot Connector

Wire Connector



RoboRuler



Chapter 1 - Base Station & Perimeter Wire Setup

1.1 Preparations

- Read carefully the Operating and Safety Manual prior to setup.
- It is recommended to mow your lawn using a conventional lawn mower and water the ground before starting the setup for easier driving of the pegs.
- Confirm all parts for the setup are included (refer to 'What's in the Box' page 10).
- During the setup you will also need the following tools:



Hammer



Combination Pliers



Small flat and Philips screwdrivers

Figure 1.1 – Tools required for the setup

1.2 Planning The Setup

IMPORTANT INFORMATION! Before starting the setup, it is necessary to first read this chapter in order to be aware of all setup rules and instructions so you are able to determine the best location for the Base Station and the perimeter wire layout.

1.2.1 Base Station Location

- Set it in the **biggest plot or zone**;
- It should be placed **along the outer edge** (if setup on the lawn area) or **outside the lawn** (refer to paragraph 1.3.2 for external setup of the Base Station);
- In the back yard, where it is **not visible to the street**;
- In a **shady spot** (better for a longer battery lifetime);
- On a relatively **level ground**;
- **Close to a wall socket** (230V / 120V) – the length of the low voltage cable is 15m (50ft) (Note: the length of the low voltage cable must not be changed).

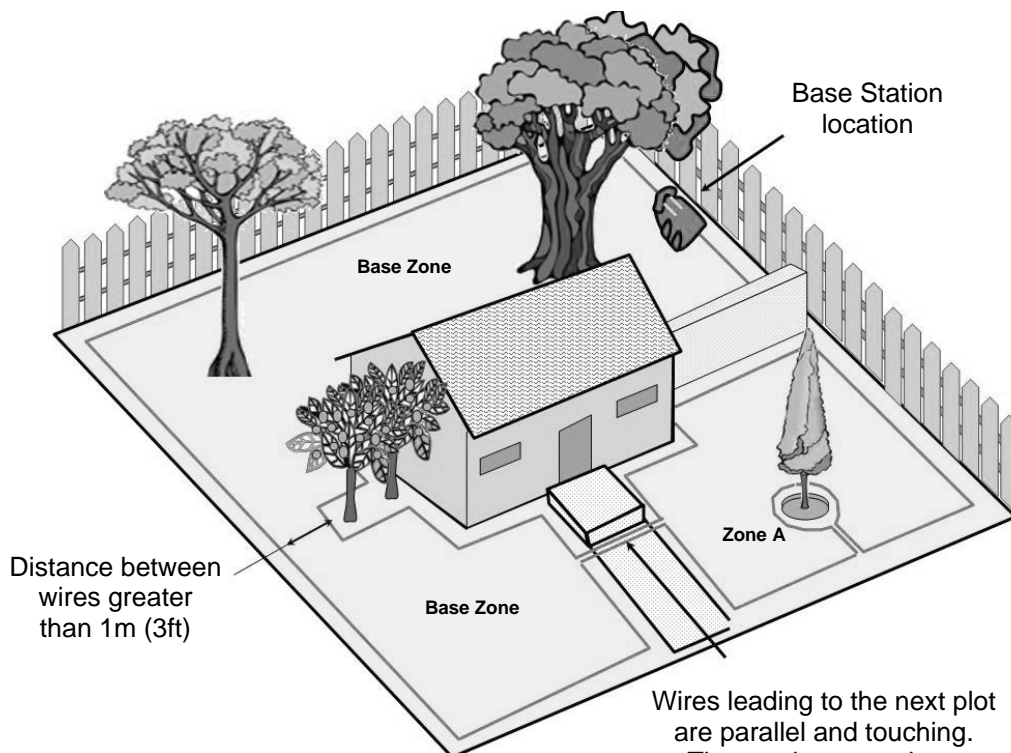

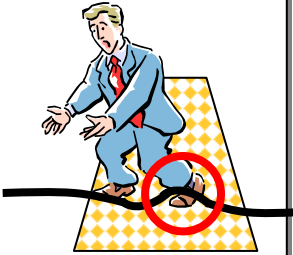

Figure 1.2 -
Base Station Location

- **Note:** The power supply is suitable for outdoor use, yet it is required placing it in a sheltered place, dry location, which is well ventilated and not exposed to direct sunlight.



WARNING!
Serious Injury Can Occur! When placing the power cord leading to the Base Station, insure it is fastened securely to the ground and does not present a tripping hazard.
Do not cross over surfaces such as sidewalks and driveways where it cannot be fastened securely.



- Place the Base Station **at least one-meter from corners;**
- Position the Base Station with its **fence facing to the inside of the lawn;**
 - Robomow is impervious to water and rain, however it is recommended to place the Base Station **away from sprinkler heads** for maximum protection.

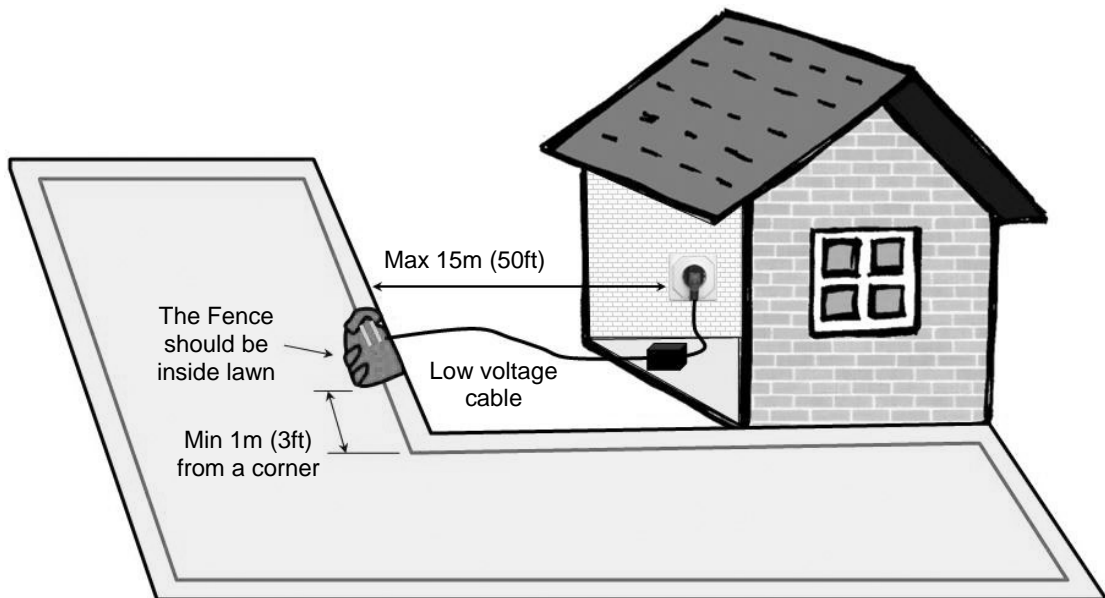

Figure 1.3 -
Base Station distance from wall socket

1.2.2 Multiple Zones/Areas And Narrow Passages

Your home may require more than one zone to be set up in order for the Robomow to work in all of your lawn effectively. Where grass areas are not contiguous, or are separated by fences, sidewalks or other objects, it is required to make each of these a separate zone.

When setting separated zones there are two options to lay the wire:

Option A: All zones are looped together and connected to the Base Station. Perimeter wire can be as long as 500 meters (1650ft) in one loop when connected to the Base Station (Figure 1.4).

Option B: There are separated zones that connected to the Base Station and the Perimeter Switch (available as an accessory- see Chapter 7). The Perimeter Switch can be moved between different zones (Figure 1.5).

To mow other areas, simply drive or carry Robomow to the area you want to mow and operate it. In this way, if one zone needs a shorter operating time than another, it can easily be set (Chapter 2.1.2). When this area is completed, drive the mower back to the station for re-charging.

Determining the distance between adjacent perimeter wires:

1. If lawns are installed by the same perimeter wire that is connected to the same source (Base Station / Perimeter Switch), then it is enough to keep a distance of one meter between the wires to prevent interference in operation.
2. If lawns are installed using different perimeter wires that are not connected, and each has its own source (Base Station / Perimeter Switch), then one of the following is required:
 - a. Maintain a minimum distance between the wires (30-50cm) to allow overlap between mowing zones, but synchronize between the mowing schedules to confirm there will not be interference between the zones. OR
 - b. Keep two meters between the perimeter wires with no need to synchronize between the operation schedules.

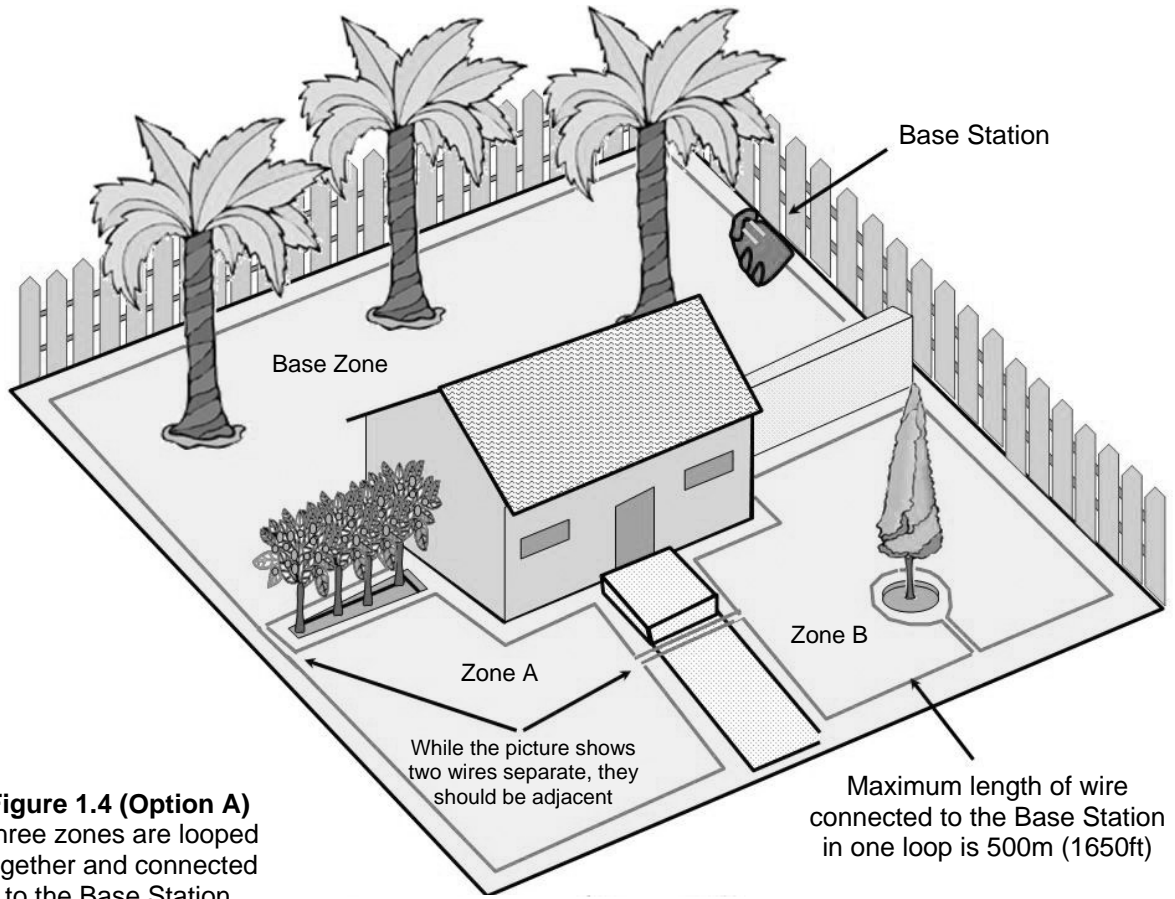

Figure 1.4 (Option A)
 Three zones are looped together and connected to the Base Station

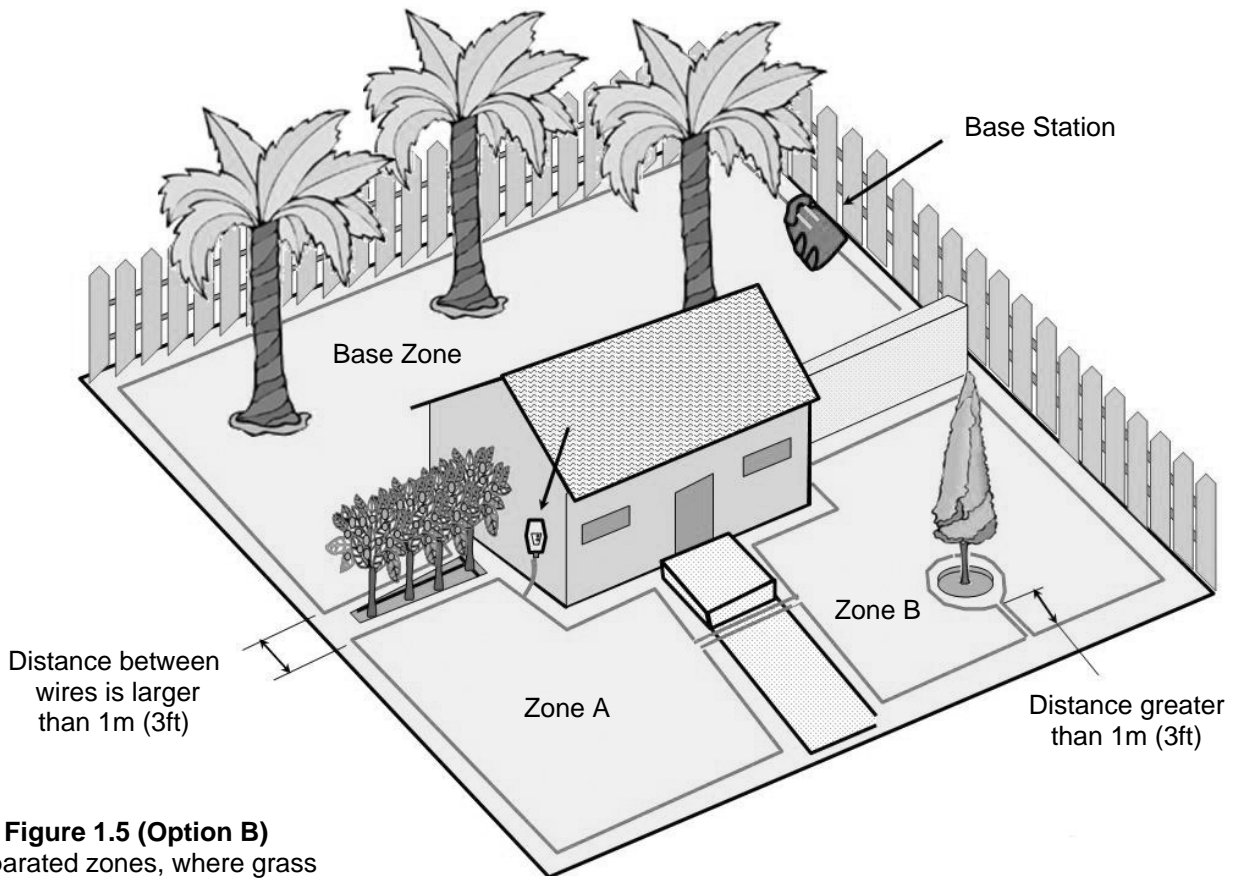

Figure 1.5 (Option B)
 Separated zones, where grass areas are not contiguous

Where grass areas are contiguous, Robomow will automatically mow all zones and drive back for recharging in the Base Station at the end of each operation.
 The area that connects two attached big areas is called a narrow pass.
 There are two types of narrow passes (Figure 1.6):

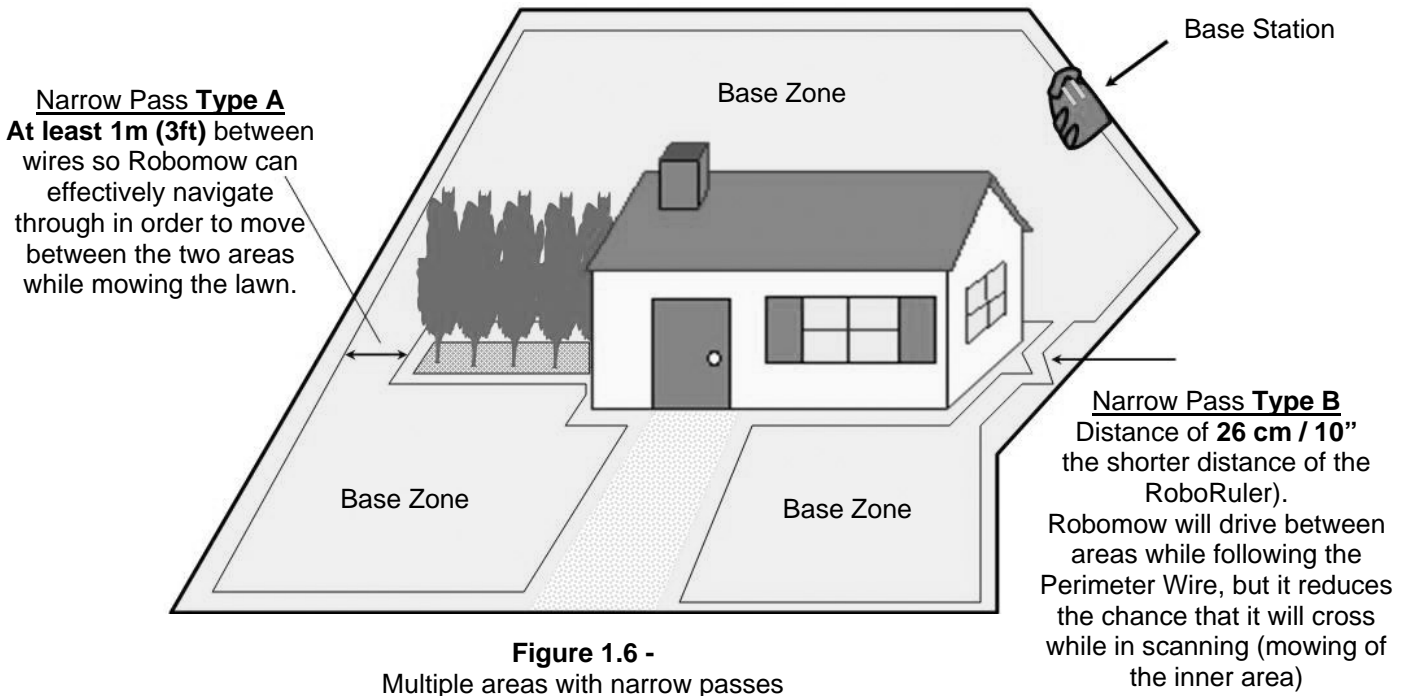
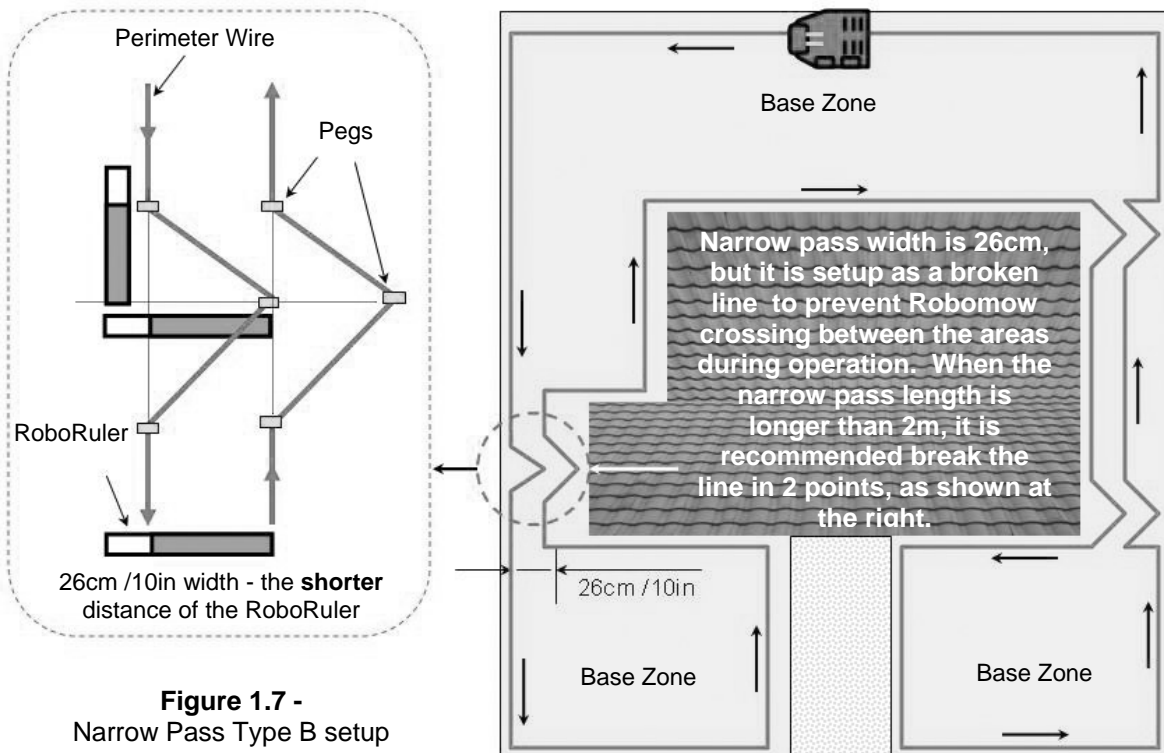

Figure 1.6 -
 Multiple areas with narrow passes

Type A: At least 1m (3ft) between the wires so Robomow can effectively navigate through in order to move between the areas during the operation.

Type B: Distance of 26cm (10 inches) between the wires (the shorter measurement of the RoboRuler), so Robomow can follow the Perimeter Wire in order to start the operation in the required area, but it reduces the chance that the mower will cross between the area while in scanning (mowing of the inner area). When setting narrow pass type B, it is required to set different entry points in order to start mowing in the different areas (to set 'Entry points' refer to Paragraph 2.1.1.2).

Setup of Narrow Pass Type B, should be 26cm (10 inches) wide all along the pass, but should be set as a broken line to reduce the chance that the mower will cross between the areas during the operation.



1.2.3 Defining Obstacles-Perimeter Islands

- Obstacles that are relatively rigid and **higher than 15cm (6 inches)**, such as trees, phone poles and power poles can be left in the lawn without any consideration during the wire setup. The Robomow will turn when it collides with this type of obstacle.
- Other obstacles such as, flowerbeds, fountains and small trees, must be protected from the Robomow using the perimeter wire. This is done as part of the setup process and is commonly referred to as a perimeter island. However, for the most gentle and silent operation, it is preferable to demarcate all fixed objects in the working area.

To create a perimeter island (Figure 1.8):

- Take the wire from the perimeter section closest to the obstacle;
- Peg it around the obstacle, using the RoboRuler short distance;
- Returning back to the same spot of the edge you started from;
- The wires leading to the perimeter island and coming back to the edge should be parallel and touching BUT they cannot be crossed. The wires to and from the perimeter island can be secured with the same pegs. The mower will not recognize these two wires and mow over them as if they do not exist. The single wire around the perimeter island will be recognized and prevent the mower from entering this area.
- Areas with obstacles grouped closely together should be covered by a single perimeter island or if they are close to the edge of the lawn, leave them out of the designated area.

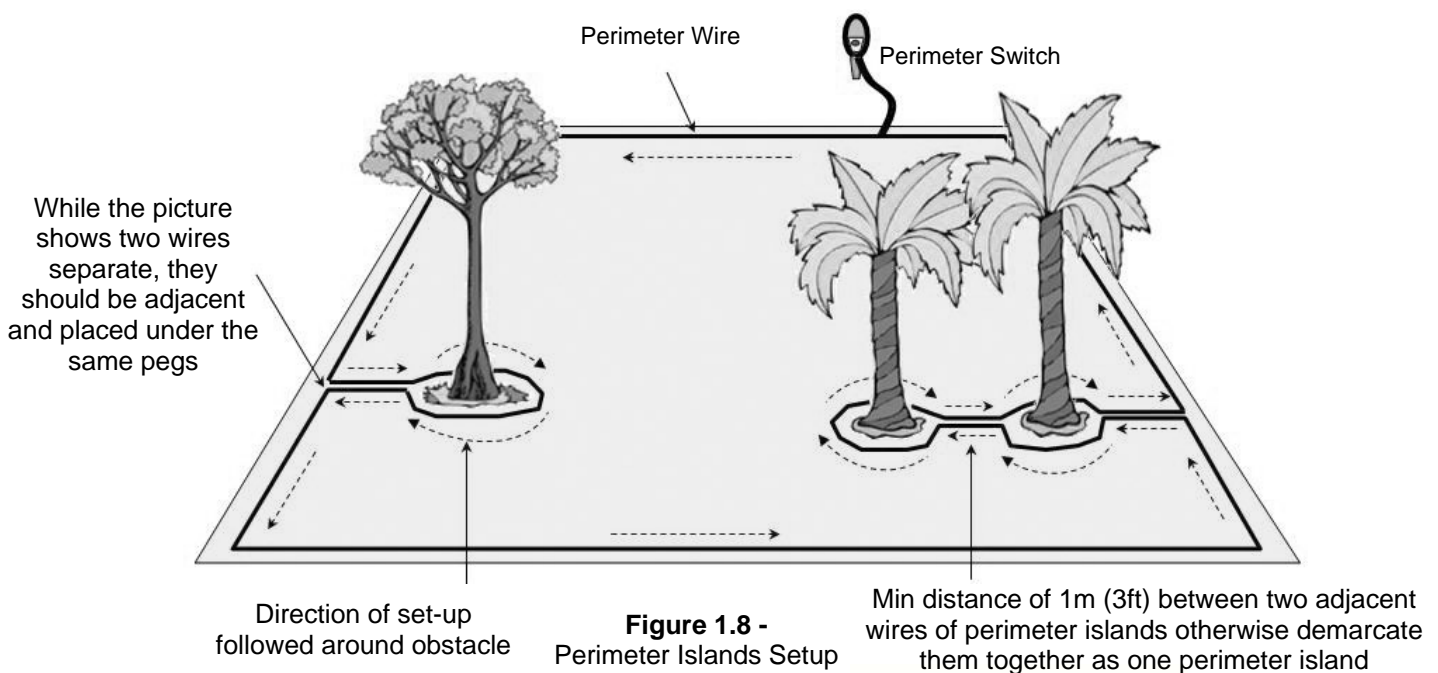

Caution! Setting the Perimeter Wire counter-clockwise around the obstacle will cause Robomow to drive into the island".



1.2.4 Slopes

The max slope allowed for the Perimeter Wire to be laid on is 15% (see area marked as 'A' in Figure 1.9).

The Perimeter Wire should not be laid across a slope that is steeper than 15cm (6in) per distance of 1 meter/3.3ft (15%). There is a risk that Robomow will find it difficult to turn and might cross the wire outside, especially in damp weather conditions, as the wheels can slip on the wet grass.

However, the perimeter wire can be laid across a slope steeper than 15% if there is an obstacle (fence, wall or dense hedge) that can prevent Robomow from slipping out of the area.

The maximum slope limit Robomow can mow inside the working area is 33%, roughly equals to 33cm (1ft) of rise per 1 meter (3ft). In any event, a slope that causes the front of the mower to raise from the ground while climbing is too steep and should not be included as part of the cutting area (see area marked as 'B' in Figure x). Sloping area greater than 33% cannot be included in the working area.

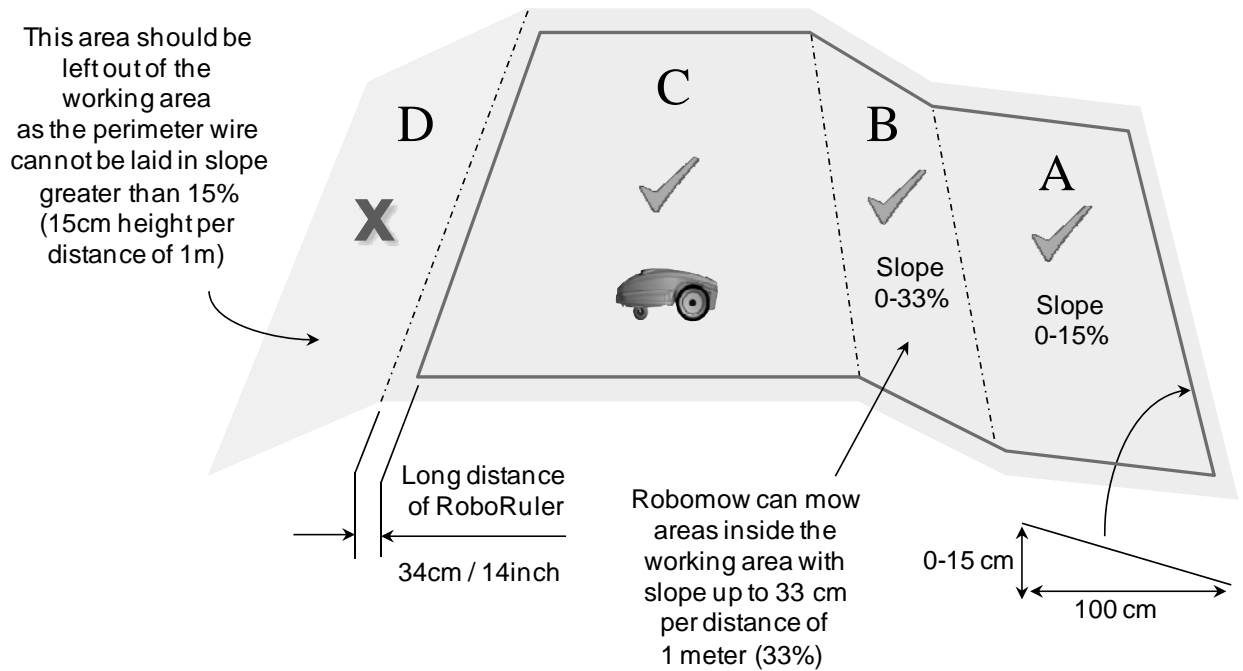

1.3 Location of the Base Station

There are two options to set the Base Station:

1.3.1 Internal (inside the lawn)

- Choose a place where you want to setup the Base Station in your lawn, based on the inputs given in paragraph 2.1.
- Place the Base Station concomitantly to the lawn edge on the lawn where the fence faces towards the inner side of the lawn (Figure 1.13).

1.3.2 External (outside the lawn)

- Choose a place outside the lawn where you want Robomow to be docked and charged.
- Confirm the pass between the lawn and the outside area is smooth with no height difference, so Robomow will not get stuck and will follow the wire smoothly.
- The surface between the lawn and the Base Station should be hard (such as a sidewalk or rigid ground) and not sandy or stoney, so Robomow will not slip or get stuck on it.
- The area between the lawn and the Base Station should be clear of obstacles and objects.

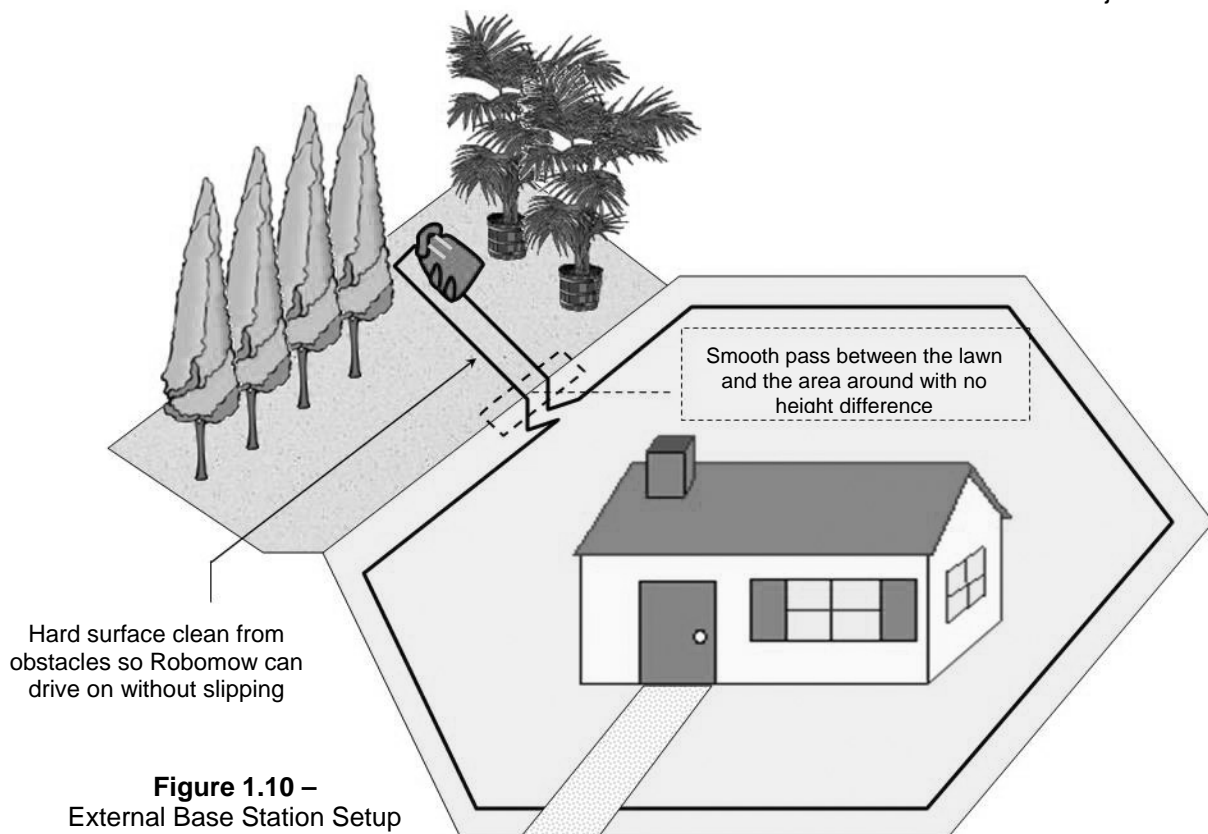

Figure 1.10 –
External Base Station Setup

- The setup of the entering to the narrow pass leads to the Base Station should include triangles to reduce the chance that Robomow will enter towards the station while mowing the inner area (scanning); to perform the triangle setup refer to Figure 1.7.
- The distance between the wires lead to the Base Station and back to the lawn is 26cm (10 inches).
- The Base Station should be placed on the right wire of the narrow pass (when standing inside the lawn).
Important: as the two wires are very close and affect the wire sensors readings, the Base Station should not be aligned with the central lines marked on the Base Station; it should be placed with a shift of 10-20cm (4-8 inches) to the right.
- It is recommended to place the Base Station at least 25cm (10 inches) before the end of the external pass to allow the mower smooth entrance to the Base Station.

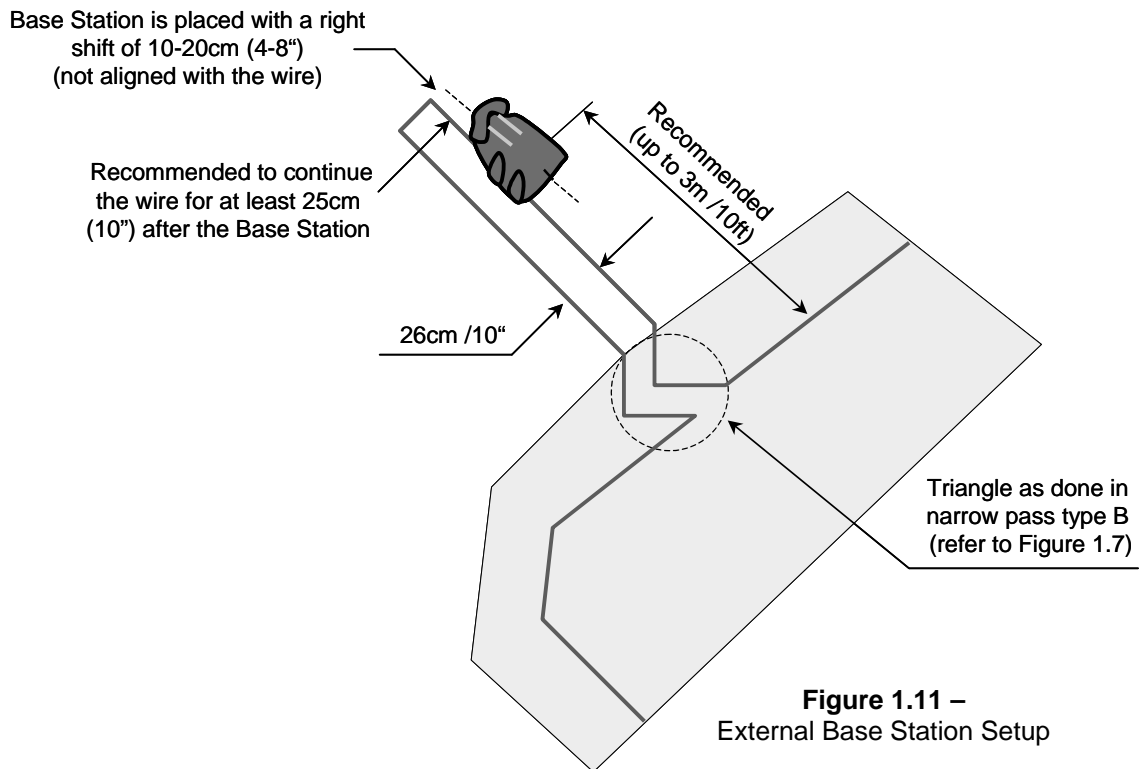

Figure 1.11 –
External Base Station Setup

1.4 Perimeter Wire Setup

Now, knowing the location of the Base Station and the planning of the wire layout, you can begin to setup the Perimeter Wire in the Base zone.

1.4.1 Starting Point

- Place the Base Station according to your plan with the fence towards the inner side of the lawn, as shown in Figure 1.11 or 1.13;
- Puncture the plastic covering of the perimeter wire and pull the wire ends with the plot connector out of the plastic covering; The connector should be connected to the wire in the polarity show in Figure 1.12;
- The plastic covering is designed as a dispenser for the wire; so do not remove the wire spool from the covering;
- Peg the beginning of the wire to the ground where the Base Station will be located; be sure to leave 30cm (12 inches) to close the loop at the end of the setup (Figure 1.13);
- Start laying the wire to the counterclockwise direction when standing inside the lawn, as show in Figure 1.13.
- Begin pulling the perimeter wire out of the plastic covering and lay it loosely as you walk along the area of the lawn to the direction shown in Figure 1.13;



Figure 1.12 – Pull out the wire from the plastic covering – do not remove the covering; it is designed as a dispenser.

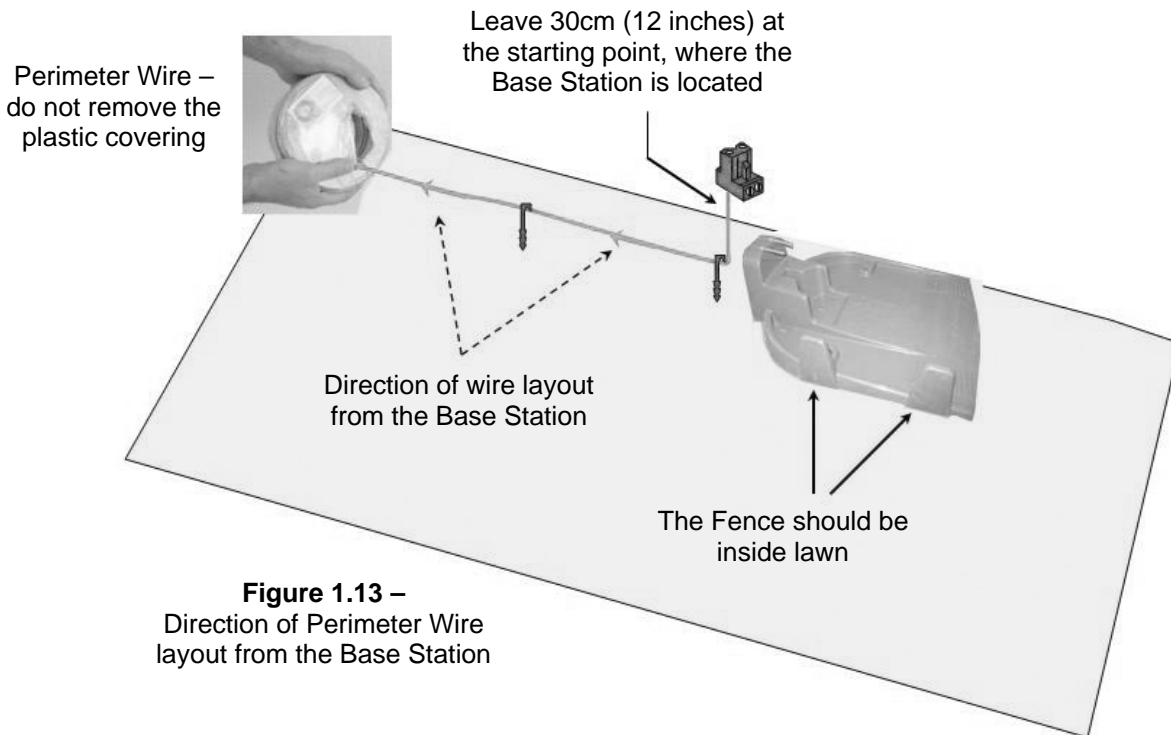

Figure 1.13 –
Direction of Perimeter Wire layout from the Base Station

1.4.2 Laying Out The Perimeter Wire

- Start setting the perimeter wire by placing pegs every few meters and at the lawn corners according to your plan; do not forget obstacles that need to be demarcated while laying the wire.
- After removing enough wire within a given section, use the RoboRuler provided to set the correct distance from the lawn edge. The RoboRuler is used to help position the perimeter wire along walls, fences, sidewalks, driveways, flowerbeds and other perimeter zones.

There are two basic measurements that are used on the RoboRuler (Figure 1.14).

The shorter distance is used along perimeter edges where the area outside the immediate perimeter is free of obstacles and is the same relative height as the perimeter edge or lower (sidewalk on the same level or flowerbeds).

The longer distance is used along perimeter edges where the area outside the immediate perimeter has obstacles or differences in the height along the perimeter edge (walls and fences).

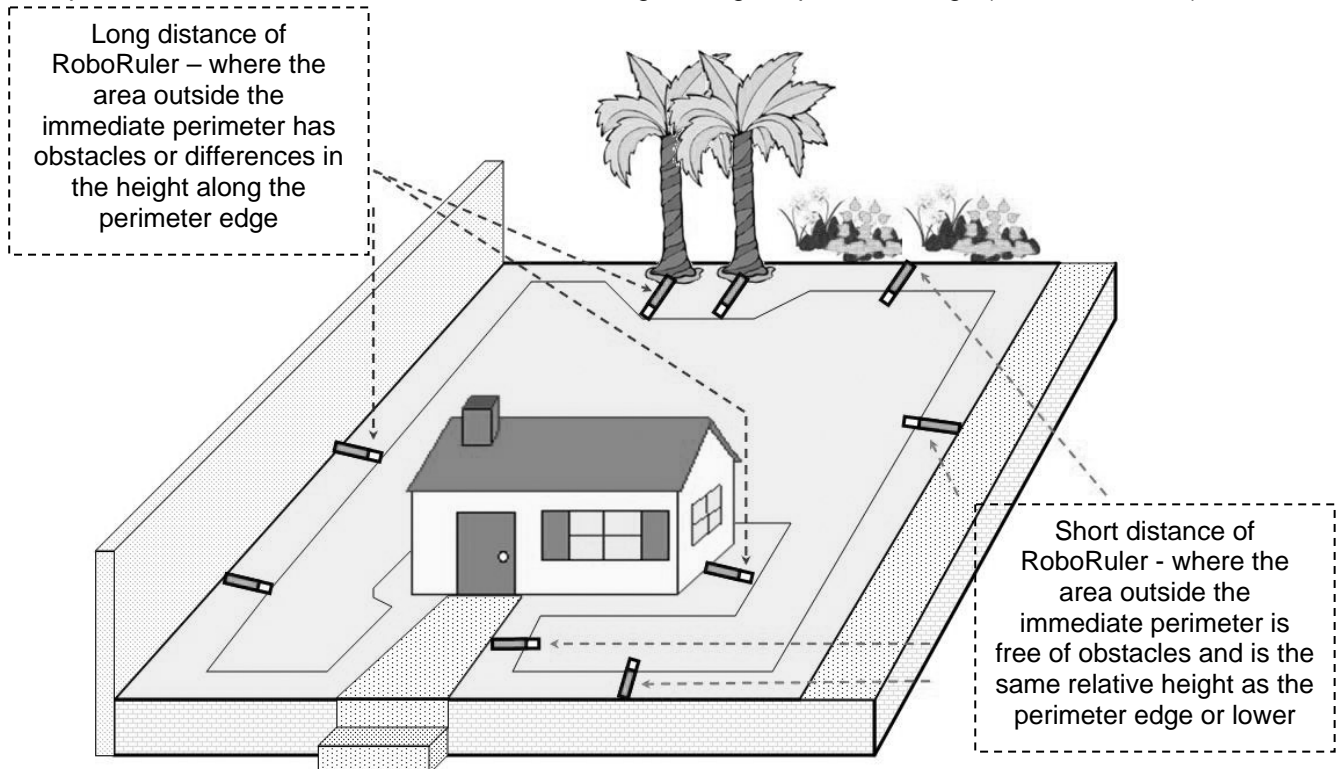

Figure 1.14 –
Using the RoboRuler

Important

If the lawn's edge borders with a pond, swimming pool or watercourse or where the grass level is higher than 70cm (2ft) from the edge around it, then it is required to keep a distance of at least 1.2m (4ft) between the wire and the water (or chasm) otherwise supplement a fence or the same along the lawn's edge, so Robomow can detect it. The height must then be at least 15cm (6 inch). This will prevent Robomow, under any circumstances, from crossing the wire outside the working area

1.4.3 Fastening The Wire To The Ground

- It is not necessary to bury the perimeter wire, though you may do so if you wish, up to 10 cm (4 inches) deep.
- Small pegs or stakes are supplied with the Robomow and they are used to fasten and hold the perimeter wire to the ground, below grass level.
- Initially place a minimum number of pegs to fasten the wire down. Remember that you will want to test the wire set up before you fill in additional pegs and you may find some areas where you will need to move the wire position slightly.
- Upon hammering the peg to its final depth in the ground, pull the wire tight. It is a lot easier to insert pegs into wet soil. If the soil is dry, water the yard before perimeter wire set up.



WARNING!

Damage to the eye is possible. Use proper eye protection and wear appropriate work gloves when hammering the pegs. Hard or dry ground may cause pegs to break when driving them in. In extreme cases, watering the lawn where the pegs will be driven can be beneficial.

- Pegs should be driven at distances between one another that will keep the wire down below the grass level and prevent it from becoming a tripping hazard (Figure 1.15).
- When properly fastened to the ground, the wire and pegs will soon disappear under the growth of new grass and will not be visible.
- If additional wire is required in order to complete the set-up, use the wire connectors provided, which are water-proof, to connect between the two wire ends, as explained in chapter 5.6.

Add pegs in to pull the perimeter wire down to the ground surface, below the grass tips.

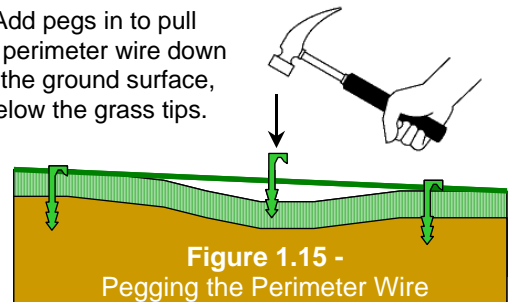

Figure 1.15 -
Pegging the Perimeter Wire

IMPORTANT INFORMATION!

Screw terminals or twisted cables, insulated with insulation tape is not a satisfactory splice. Soil moisture will cause the stripped wire ends to oxidize and after a while result in broken circuit.

1.4.4 Completing The Perimeter Wire Setup

- Once the perimeter wire is completed and pegged to the ground, the last step to complete is attaching the perimeter wire ends to the Base Station board and testing the setup.
- There are two loose wire ends where the perimeter wire set up was started (Figure 1.16).
- Use the same peg to fasten these two perimeter wire ends down to the ground and twist them.
- Cut the wire end without the connector so they are of equal length - removing any excess wire.
- Strip back 6 mm of insulation from the wire end (Figure 1.17).
- Insert the free perimeter wire into hole of connector using a small flat screwdriver; tighten the screw to secure the perimeter wire into the connector (Figure 1.18).



Figure 1.16 -
Two loose wire ends
at the starting point



Figure 1.17 -
Strip 6mm of insulation
from the wire end



Figure 1.18 -
Tighten the screw to secure the
perimeter wire into the connector

1.4.5 Placing and Connecting the Base Station

- Connect the Perimeter Wire connector to the Base Station board (Figure 1.19).
- Before securing the Power Supply cord to the Base Station, carefully lay the length of the cord out, beginning from the Base Station and leading to the main power supply and insure it is fastened securely to the ground and does not present a tripping hazard.
- Do not cross it over surfaces where it cannot be fastened, such as sidewalks or driveways. For ultimate protection, consider an underground placement within a protective conduit.
- Connect the Power Supply cord to the Base Station board. See Figure 1.20.
- Route the Power Supply cord into the Base Station cover as shown in Figure 1.21.
- Close the cover of the Base Station; confirm it is locked well in its place (Figure 1.22).

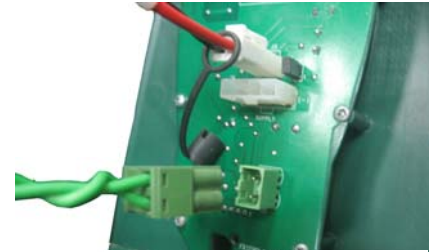

Figure 1.19 -
Perimeter Wire connection
to the Base Station

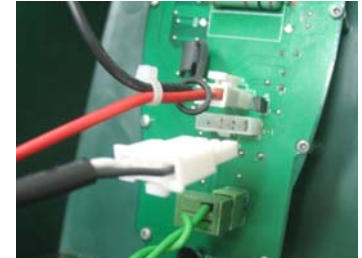

Figure 1.20 -
Power Supply cord connection



Figure 1.21 -
Routing the Power Supply
cord out of the cover



Figure 1.22 -
Closing the Base Station cover

- Align the Base Station on the Perimeter Wire, so the wire is aligned with the two central lines marked at the front and rear side of the Base Station, as shown in Figure 1.23. Do not fasten the Base Station yet, as you will want to check its final position first.

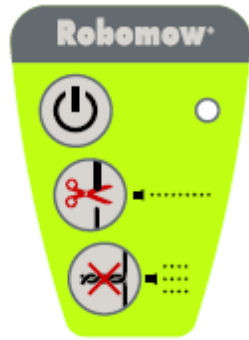

Figure 1.23 -
Base Station alignment



- Connect the power supply to a regular household receptacle 230 Volts AC.
- A small flashing green light in the Base Station cover indicates the system is on and functioning properly. Continuous beeps indicate a disconnected/broken perimeter wire. Discontinuous beeps indicate poor splicing of perimeter wires or perimeter wire, which is too long (the max allowed in one loop is 500 meters).

Figure 1.24 -
Base Station
Operating Panel



Flashing light
indicates the system

Continuous beeps indicate a
disconnected/broken wire

Discontinuous beeps indicate
poor splicing of perimeter wires
or perimeter wire, which is too

1.5 Robomow Preparation and Settings

1.5.1 Setting the Cutting Height

- Lift the Bumper Cover from the front side of the Robomow (figure 1.25).
- To change the cutting height, rotate the cutting height adjustment knob, as shown in figure 1.26.

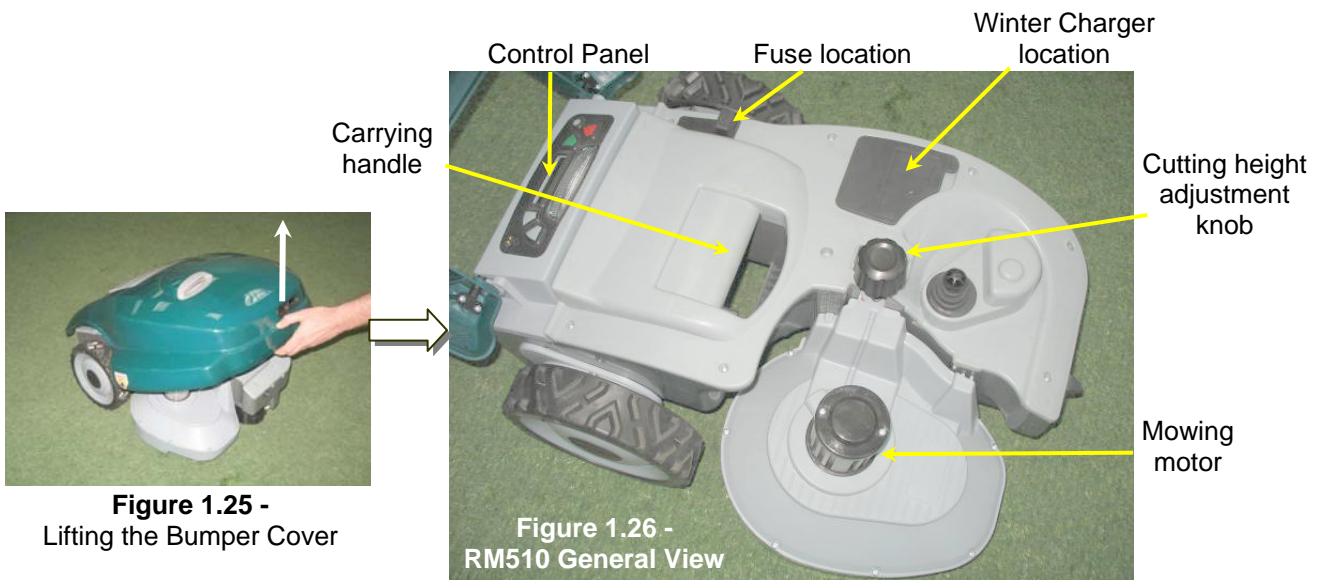

Figure 1.25 -
Lifting the Bumper Cover

Figure 1.26 -
RM510 General View

1.5.2 Inserting Batteries Fuse

- Your Robomow is shipped with the batteries fuse removed and it will not operate without it. The fuse is assembled inside its rubber cover, located under the Bumper Cover (Figure 1.27).
- Lift the Bumper Cover, remove the partition and insert the fuse. The fuse can be inserted in either direction. See figure 1.27
- Robomow will now power up (wake up). The Batteries are charged at the factory and have plenty of power to perform the initial setup and test run. However, after the initial set-up process is completed the batteries need to be charged 16 hours in the Base Station before the first operation.



Figure 1.27 -
Inserting batteries fuse

1.5.3 Robomow Settings

- **Control Panel**

- On the top of the rear side of Robomow there is a control panel. The control panel consists of a display, keypad and operating lamp (figure 1.28).

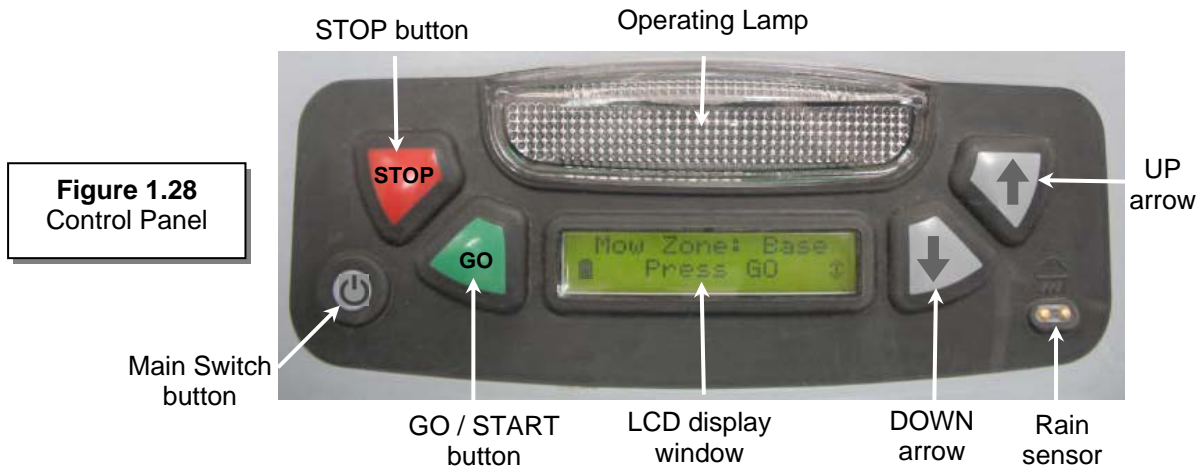

Figure 1.28
Control Panel

- The 'GO' button is used as a means to select or confirm different menu options or settings;
- 'Up ↑ / Down ↓' arrow keys will allow you to scroll through the menu items;
- The 'STOP' button has two different functions: when pressing during automatic operation it will stop Robomow and blade operation immediately and when pressing at any time during the menu selection process it will bring you one step back in the menu.
- 'Main Switch' button is used to switch off the Robomow. It is required to switch off the Robomow when carrying it between zones.

IMPORTANT INFORMATION!

Follow the instructions on the LCD display - Robomow will friendly instruct you, step by step, how to complete the setup

- **Language, Time and Date settings**

- 'Language' is the first setting you are asked to set, as Robomow wakes up. Follow the instructions below, as shown in figure 1.29.



Press 'GO'

Scroll 'UP' or 'DOWN' to choose your language and press GO to confirm

Please note that there are 'English' and 'English (US)' under the 'Language' menu, as the language defines also the 'Time and date' format.

Press 'GO'

Scroll to set the time and date and press 'GO' for the next digit ('STOP' is used to go back)

Press 'GO' to confirm and continue with the instructions at the next subparagraph ('weekly program' setting)

Figure 1.29
Language, Time and Date setting

- **Weekly Program**

- The 'Weekly program' menu allows you to set an automatic weekly program by the size of the area connected to the Base Station (follow the steps shown in figure 1.30 below).
- By setting the area of the zone connected to the Base Station, Robomow will automatically determine the most suitable weekly program to your lawn.
- Robomow will start mowing at **13:00** on the active days and will drive back for charging in the Base Station at the end of the operation.



WARNING! Never let Robomow operate without supervision. Serious injury can occur. If the current date and time are not set correctly or are failed to be set when prompted, the times scheduled for automatic departure will not be correct. Incorrect departure times can be dangerous if children, pets or bystanders are present in the mowing area.

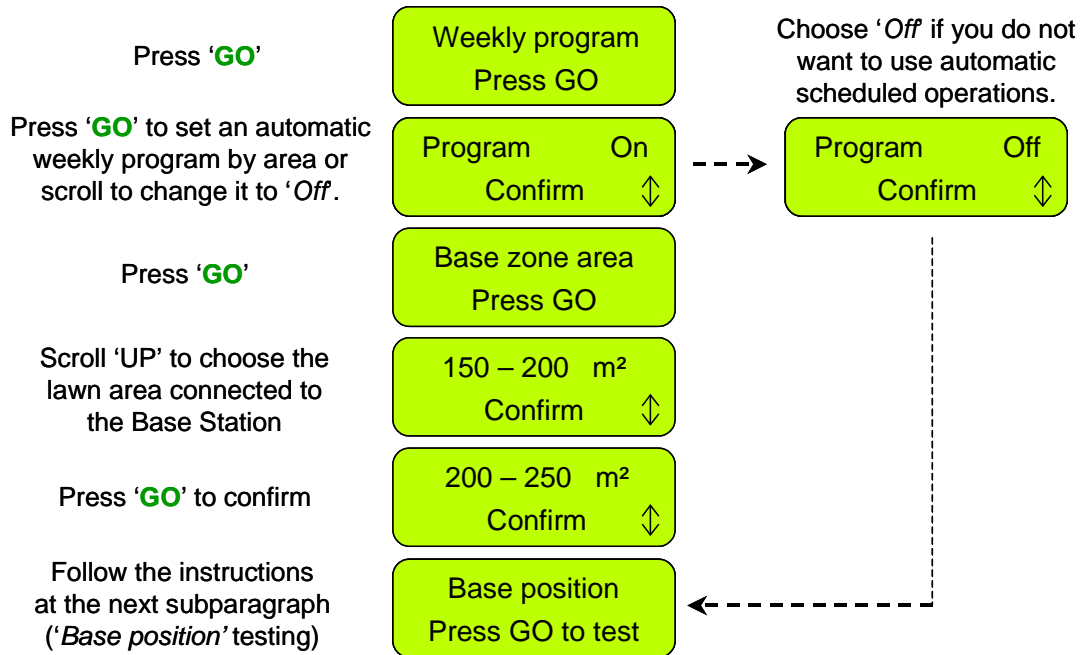
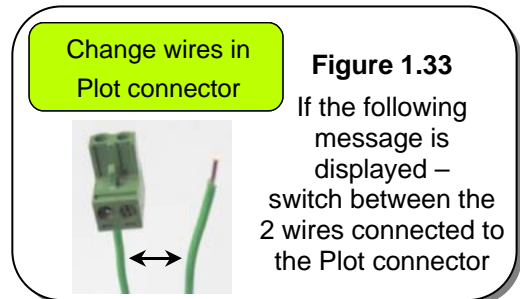
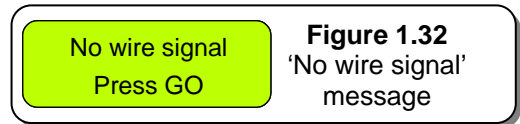
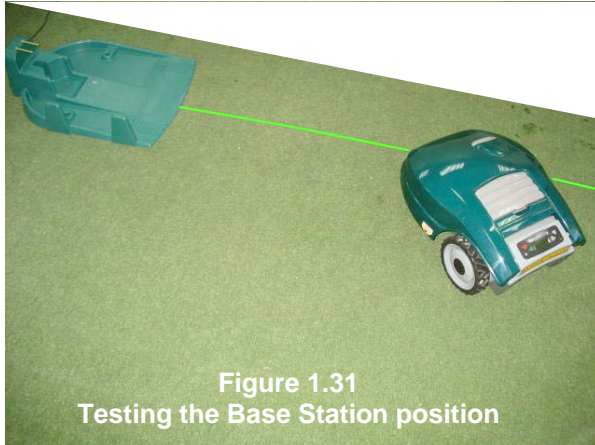

Figure 1.30
Weekly program setting

1.6 Testing the Base Station and Perimeter Wire Position

- It is required to test the position of the Base Station and the Perimeter Wire to determine if any small adjustments need to be made.
- Position the Robomow **inside** the lawn towards the perimeter wire, at least 2 meters from the Base Station (figure 1.31) and press the 'GO' button.
- In a case you forgot to connect the Power Supply to a regular household receptacle 230 Volts (120V), '**No wire signal**' message will be displayed on the LCD upon pressing GO, reminding you to connect the Power Supply (Figure 1.32).
- In a case you connected the Perimeter Wire in the opposite direction, '**Change wires in plot connector**' message will be displayed upon pressing GO, instructing you to switch between the two wires connected to the Plot connector (Figure 1.33).



- Follow the instructions, as shown in figure 1.35 to complete the test of the Base Station position:

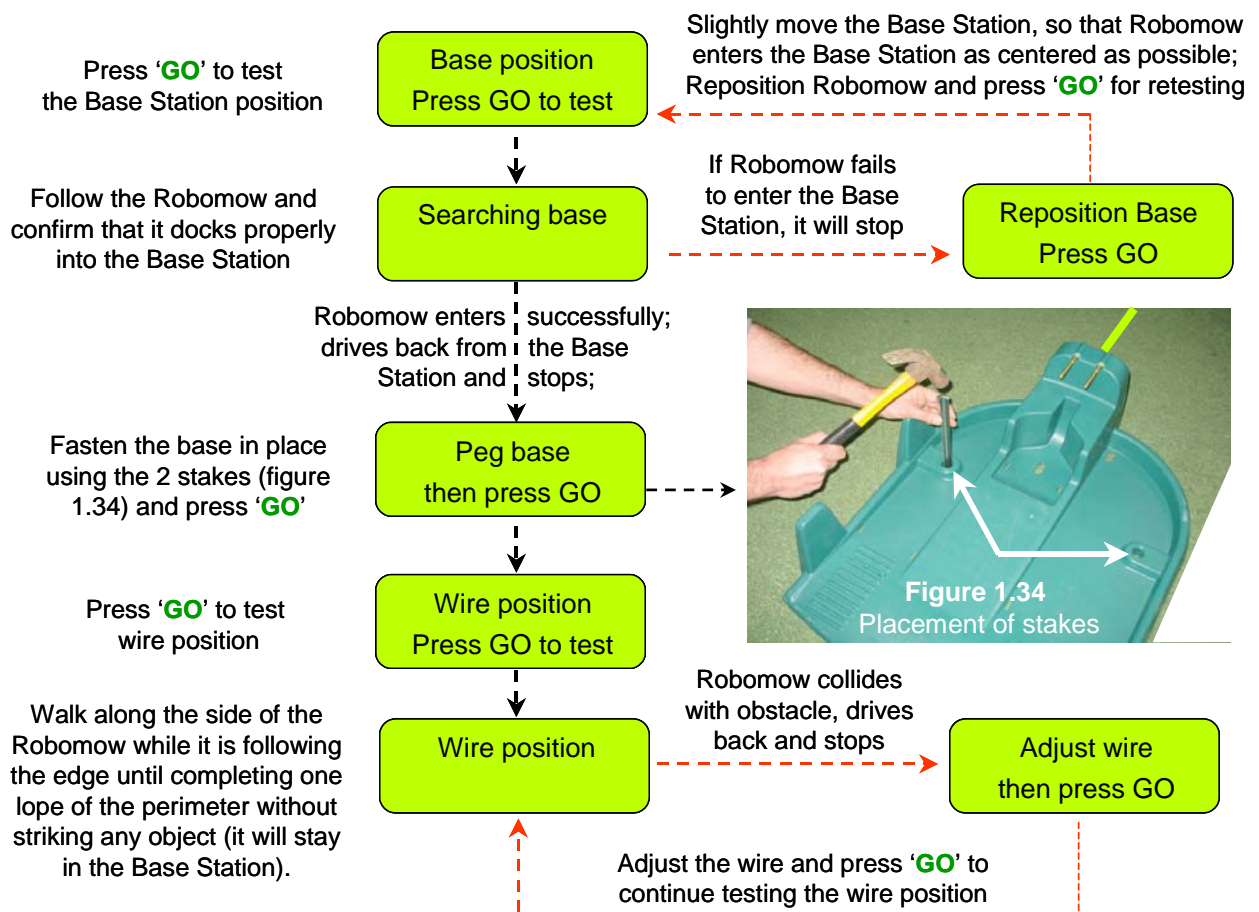

Figure 1.35
Testing the Base Station and Perimeter Wire Position

Completing the Wire Fastening

- Once complete, walk back along the perimeter and add in wire pegs to those areas of the wire where it is not pulled down below the level of the grass tips and close to ground level. Wherever the wire is raised or loose, it should be tightened and pegged down with extra wire pegs (distance between pegs should be 0.5 to 1 meter (1.5-3 ft) in straight line and more when curved).

1.7 Setup in None-Base Zone

Note: Setup in a non-Base zone, which is not connected to the Base Station, requires a Perimeter Switch (available as an accessory - see Chapter 7 - Accessories).

1.7.1 Perimeter Switch Location

- Find a convenient spot **outside the perimeter** of the non-Base zone, but a location that is relatively easy for you to access.
- The Perimeter Switch must be **mounted vertically** in order to maintain its' water resistance and preferably in a **dry and sheltered location**.
- Close to a wall socket** (230V/120V) – the Perimeter Switch is supplied with an indoor power supply (Figure 1.36).

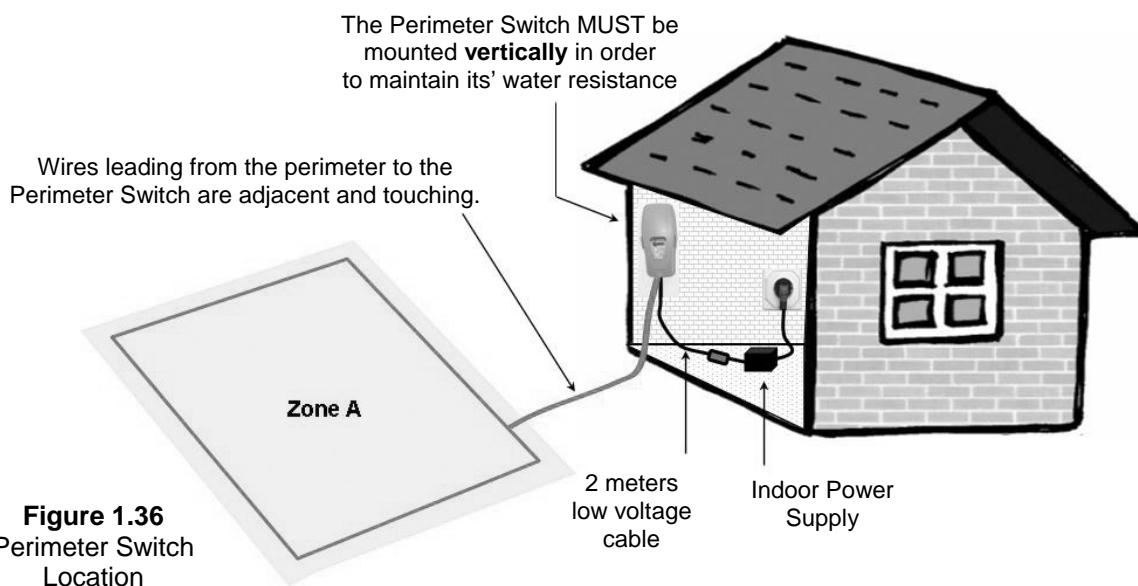

Figure 1.36
Perimeter Switch Location

1.7.2 Placing the Perimeter Switch

- The Perimeter Switch connector is designed for quick and easy disconnection that allows you to easily move the perimeter switch between plots.
- The Perimeter Switch also comes with a large stake that fastens to its back, making transfer from one plot to another easier by allowing you to disconnect the switch and move it with the stake still attached (Figure 1.37).
- Another option is to mount the Perimeter Switch onto a vertical surface, such as a wall or deck railing. There are three small bosses on the back of the switch cover in order to mount it this way. (Figure 1.38).

Figure 1.37
Perimeter Switch with stake attached



Figure 1.38
Squeeze the tabs on both sides to remove cover



Mounting the Perimeter Switch using three mounting bosses on back cover

1.7.3 Laying Out The Perimeter Wire

- Now, knowing the Perimeter Switch location, you can begin the setup of the Perimeter Wire, as was explained in articles 1.2 and 1.3. The perimeter wire setup in a Base and non-Base zone is identical in terms of placement and fastening;
- At the location of the perimeter switch, strip back 5 mm (0.2 inches) of insulation from the wire end.
- Insert the wire end to the left side of the plot connector, as shown in figure 1.39 and tighten the screw.
- Peg/fix the beginning of the wire where the Perimeter Switch will be located;
- Lay the wire from the Perimeter Switch to the lawn; be sure to leave enough wire at the beginning to close the loop;
- Start laying the wire to the counterclockwise direction when standing inside the lawn, as show in Figure 1.39.

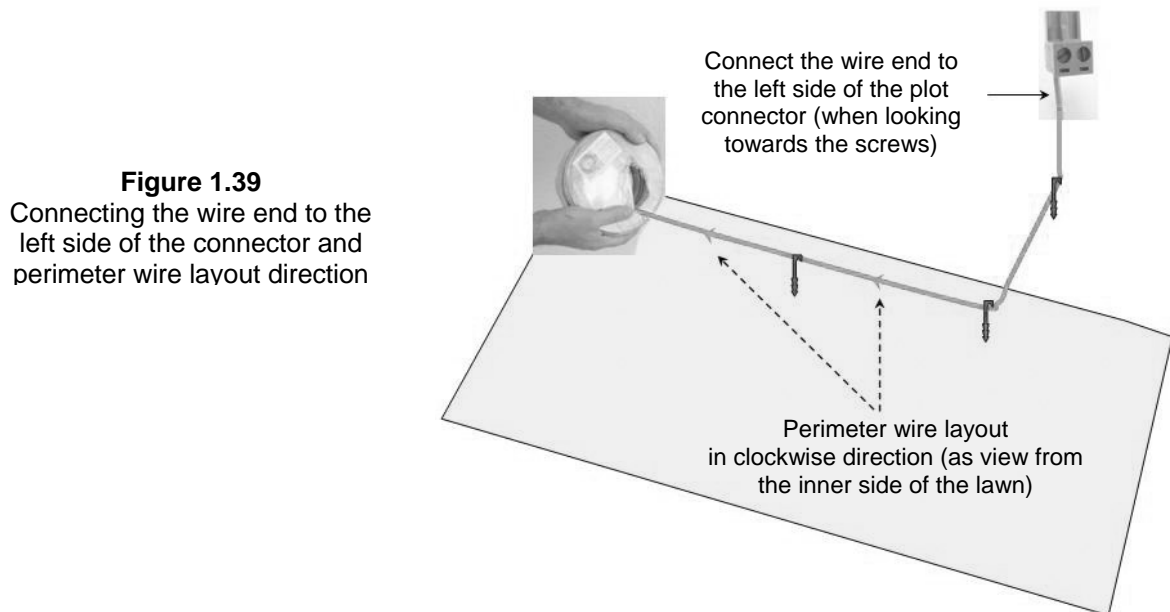

Figure 1.39
Connecting the wire end to the left side of the connector and perimeter wire layout direction

1.7.4 Completing And Testing The Setup

- Once the perimeter wire is completed and pegged to the ground, the last step to complete is attaching the Perimeter Switch to the perimeter wires and testing the setup.
- Pull the two loose perimeter wire leads taut and peg them down to the ground (figure 1.36), adjacent to one another, as you move away from the perimeter and towards the Perimeter Switch location (use the same pegs to attach the two wires from the lawn to the Perimeter Switch location).
- At the location of the perimeter switch, cut the loose perimeter wire so both wires are of equal length, removing any excess wire. Strip back 5 mm (0.2 in) of insulation from the wire end. Insert the wire end to the free hole in the connector and tighten the screws as shown in figure 1.40.
- Plug the perimeter wire connector into the Perimeter Switch (see figure 1.41)

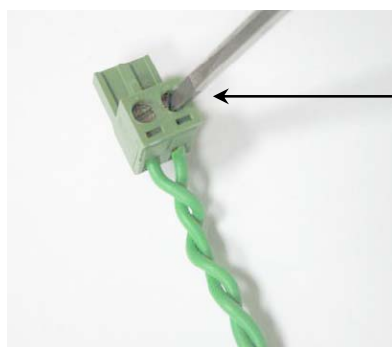

Figure 1.40
Inserting and Fastening Perimeter Wire to Connector



Figure 1.41
Plug the plot connector into the Perimeter Switch

- Take the Perimeter Switch and squeeze the tabs on both sides of the Perimeter Switch, (as shown in figure 1.42A) and remove the back cover from the Perimeter Switch.
- Connect the power supply plug to the Perimeter Switch board (see figure 1.42B) and reassemble the Perimeter Switch.
- Connect the power supply to a regular household receptacle 230 Volts AC;
- The Power Supply is for indoor use only, thus place it in a dry location, which is well ventilated (do not cover it with plastic bag); be sure the power supply and the connection to the low voltage cable are in a dry place and not exposed to water and rain.



Figure 1.42B

Connect the power supply plug to the Perimeter Switch board

- Press the '**ON**' button. A small flashing green light next to the '**ON**' button indicates that the system is on and functioning properly. The Perimeter Switch also has indicators for a disconnected/broken perimeter wire and for poor wire splicing. Figure 1.43

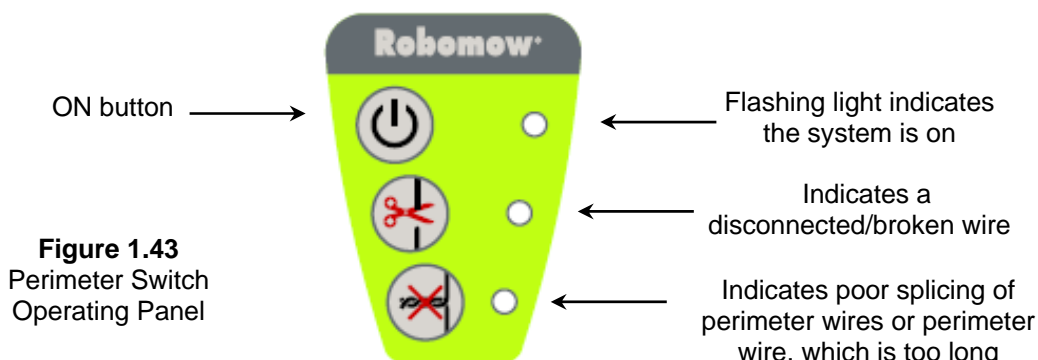

Figure 1.43
Perimeter Switch
Operating Panel

- The Perimeter Switch has an automatic shutoff feature, eliminating the need for you to turn it off after each use. It will shut itself off after 12 hours of operation. You may manually turn the perimeter switch off by pressing the '**ON**' button continuously for 3 seconds. A beep will be heard after the three seconds, indicating you may release the button and the switch is off. Test the perimeter wire setup by choosing the '**Wire position**' menu as shown in figure 1.44. Robomow will follow the wire, while the mowing motor is switched off to prevent any damage to the perimeter wire after the initial setup; Walk along the side of the Robomow while it is following the edge until completing one loop of the perimeter without striking any object; If Robomow collides in obstacle, it stops and drives back to allow you adjusting the wire position.

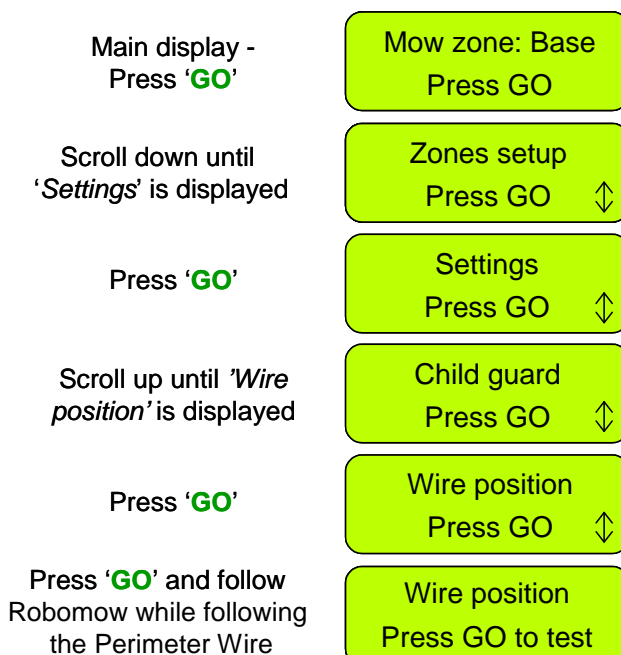

Figure 1.44
Testing the Perimeter
Wire position

Chapter 2 - Menu

Chapter 2 introduces Robomow menu functions. To use the control panel read the instructions in paragraph 1.5.3.

The main menu consists of four options:

- 2.1 Zones setup
- 2.2 Settings
- 2.3 Information
- 2.4 Service (password is required)

Note: the numbers 2.1-2.3 refer to the headings on the coming pages.

To browse through the main menu and the submenus, use the '**GO**' button as a means to select or confirm different menu options or settings. Pressing the '**GO**' button will generally select or confirm the text message shown on the second line of the LCD. There are several settings, which the user can make changes to and features that can be enabled/disabled. Pressing the '**STOP**' button at any time during the menu selection process will bring you one step back in the menu. To scroll between the submenus use the '**UP**'/'**DOWN**' arrow keys.

To see the main menu functions (options 2.1 to 2.4 - Figure 2.1), follow one of the following options:

1. When the mower is **out** of the Base Station scroll down to the 'User options' display and press '**GO**';
2. When the mower is **in** the Base Station, simply scroll down to the menu you want.

Figure number 2.1 shows the main menu and the submenus available under each of the options. There are more submenus in the next level of the menu tree that are explained in the next pages of this chapter.

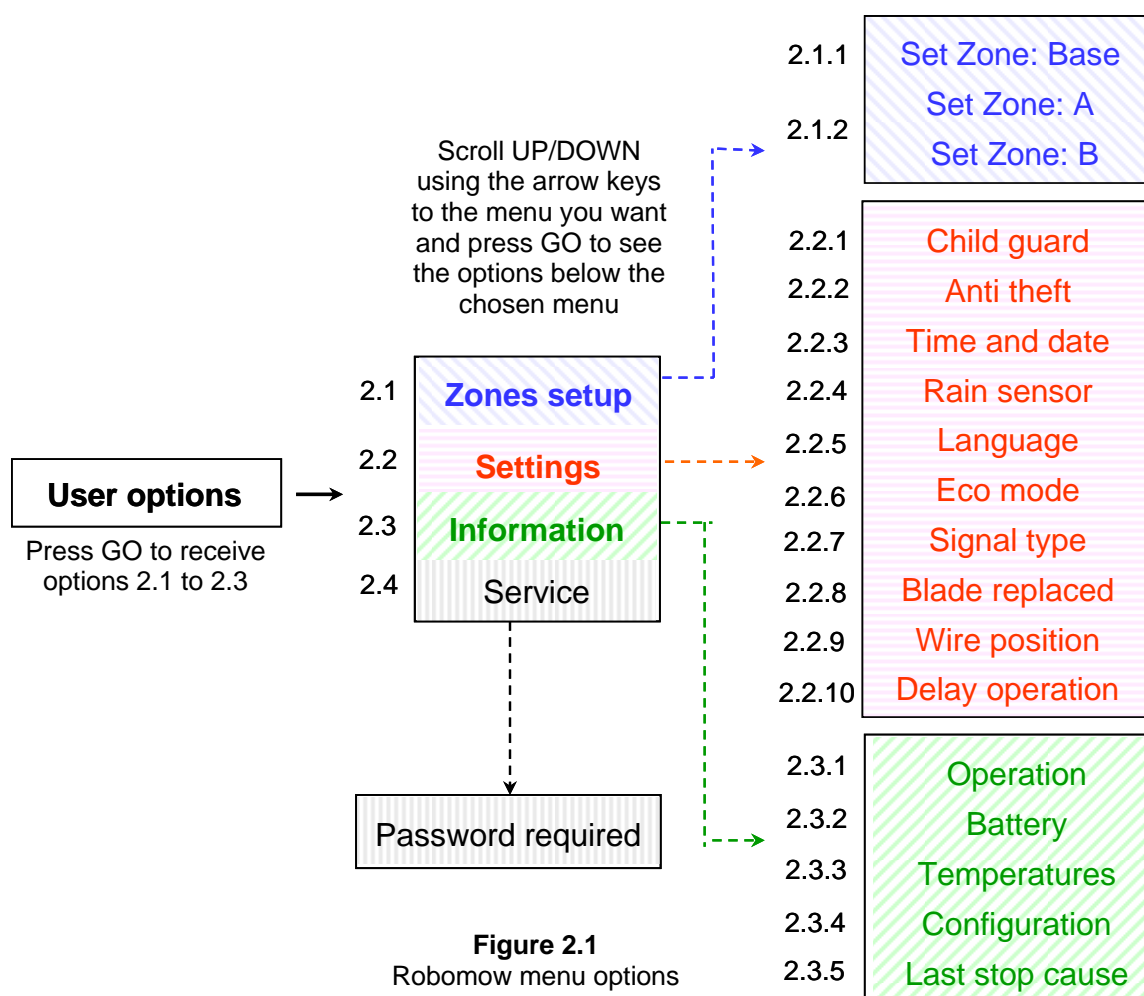

Figure 2.1
Robomow menu options

2.1 Zones setup

The '**Zones setup**' menu allows user to set the **parameters that are specific per zone**.

It is possible to set up to three different zones: zone Base, zone A and B, when the main zone is **Base Zone**, the area where the Base Station is located (for multi zones setup refer to paragraph 1.2.2).

2.1.1 Set Zone: Base

Enables to set all the parameters that are specific to Zone Base (paragraphs 2.1.1.1 to 2.1.1.6).

2.1.1.1 Weekly program

The '**Weekly program**' menu consists of four options (figure 2.2):

- Update program – allows updating the program and changing the settings.
- Program type – allows setting the program type, when every type gives a different level of the parameter the user can set (more details will follow).
- Program on/off - Allows user to shut off the weekly program when setting the '**Program**' to '**off**'. A shortcut to shut off the weekly program is by pressing the main switch while Robomow is in the Base Station. It will set the program to 'off' but will allow manual start by pressing the GO button as well as charging.
- Display program - the weekly program display is used to show the active days and additional information about the last week operations (more details will follow).



Figure 2.2
Weekly program menu

When setting weekly program by area, the active days will be as shown in the table below.

Active days per area

| Area m ² | Mon | Tue | Wed | Thu | Fri | Sat | Sun |
|---------------------|-----|-----|-----|-----|-----|-----|-----|
| 0-50 | | √ | | | √ | | |
| 50-100 | | √ | | | √ | | |
| 100-150 | √ | | √ | | √ | | |
| 150-200 | √ | √ | | √ | √ | | |
| 200-250 | √ | √ | √ | √ | √ | | |
| 250-300 | √ | √ | √ | √ | √ | √ | |
| 300 and up | √ | √ | √ | √ | √ | √ | √ |

- Program type

There are three types of weekly programs that can be set by the user:

- **Set by area:**

Define the area size of the zone connected to the Base Station and the start time, at which you wish Robomow to start mowing; Robomow will determine the most efficient weekly program to your lawn based on the area given. Follow the screens and the instructions below (figure 2.3) to set weekly program by area:

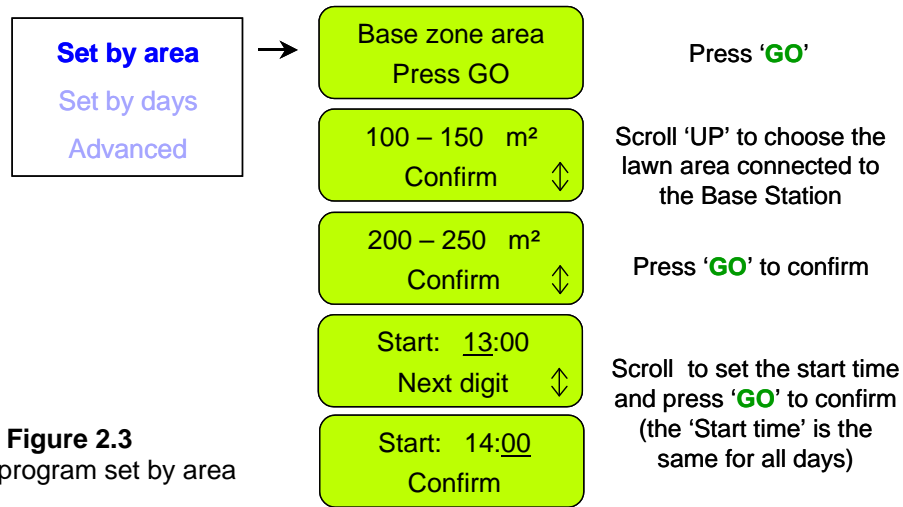

Figure 2.3
Weekly program set by area

- **Set by days:**

Select the days in which you wish Robomow to operate. Define the start time and the work time, which are common to all active days; Follow the screens and the instructions below (figure 2.4) to set weekly program by days:

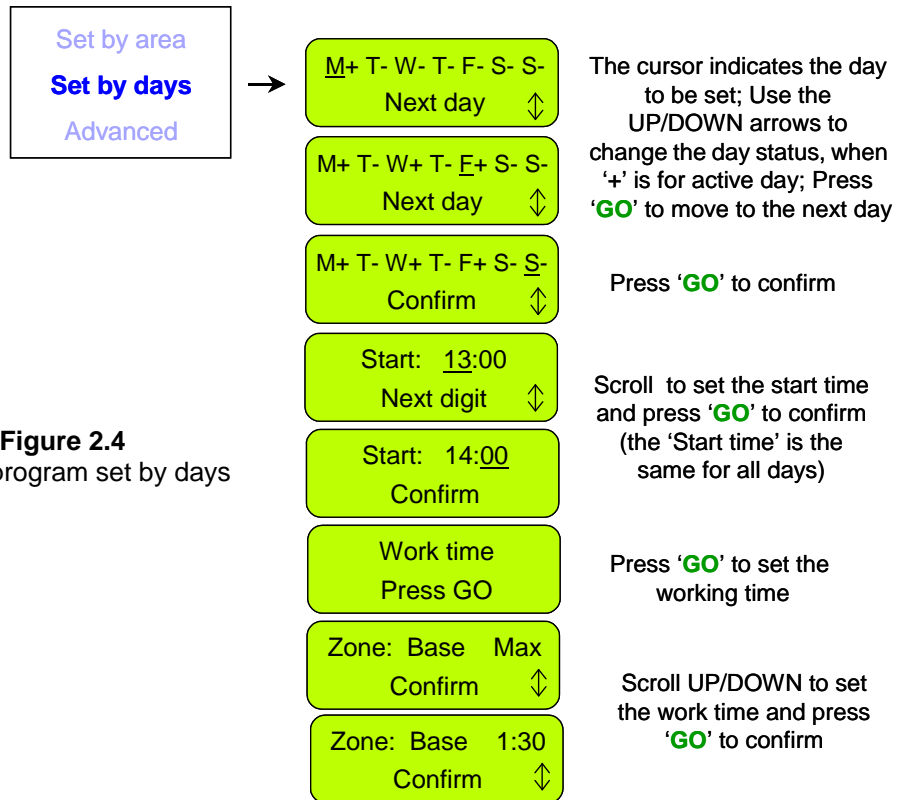

Figure 2.4
Weekly program set by days

- **Advanced:**

The advanced program should be used in multiple zones, as it allows the user to set all parameters differently per day (entry point, start time, work time and operation mode); Follow the screens and the instructions below (figure 2.5) to set the advanced weekly program:

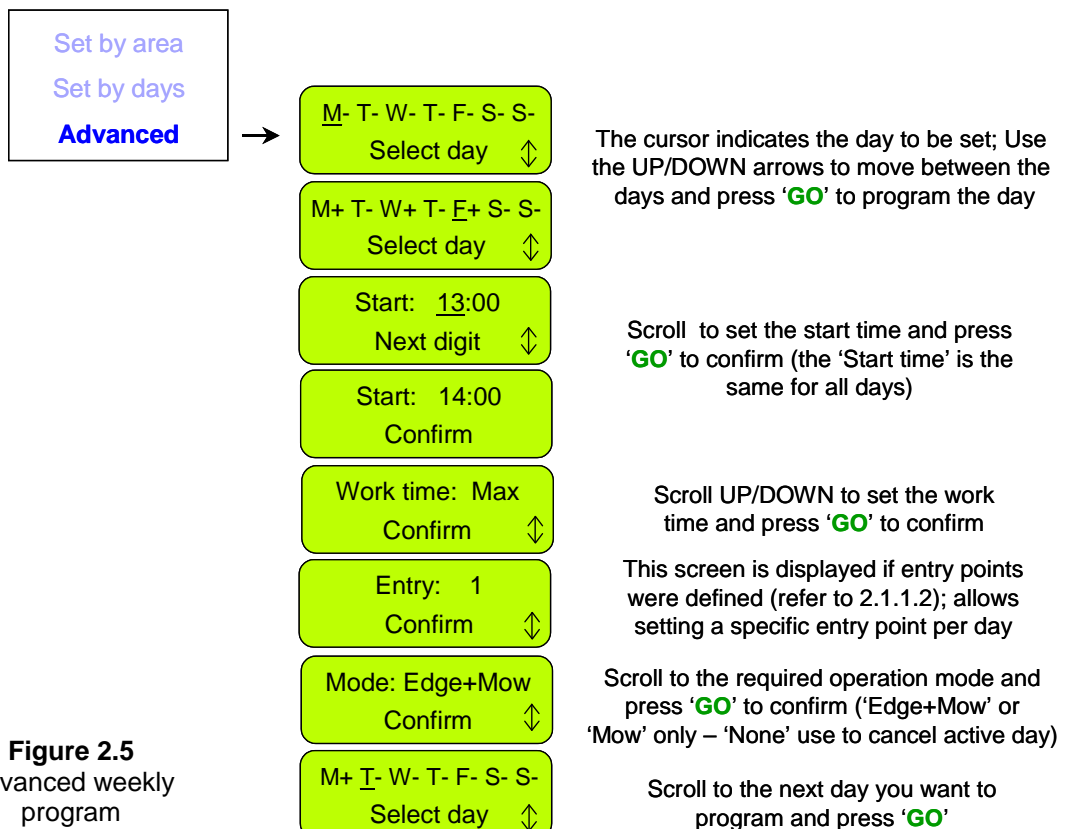
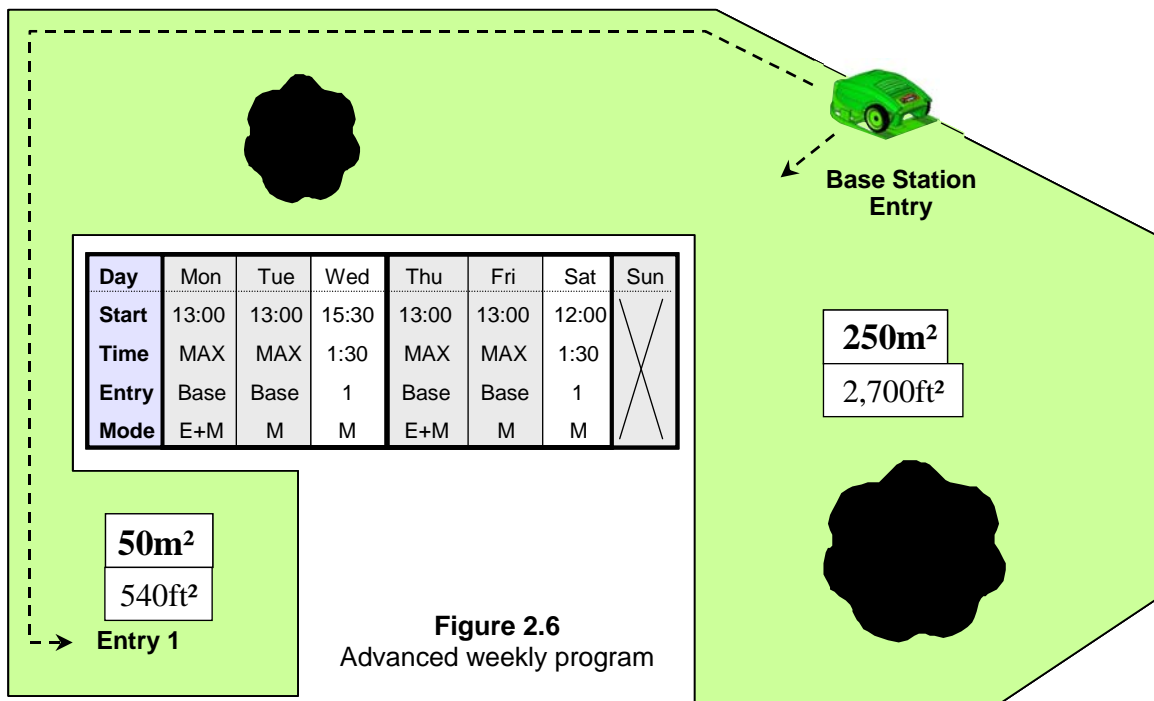

Figure 2.5
Advanced weekly program

Example for using the advanced program (Figure 2.6)

- The lawn in figure 2.6 has two areas with narrow pass between them;
- The large area is 250m² where the small area is 50m², thus different work times are required to each of the areas;
- The mower cannot cross between the areas while working inside the lawn, but only when following the perimeter wire, thus an additional entry point is required to start the operation in the smaller area of 50m² (to set entry points refer to paragraph 2.1.1.2);
- Robomow mows about 130m² per full operation, thus 2 operations are required to mow the bigger area and one operation of 1:30 hours is enough to cover the smaller area;
- The table in figure 2.6 shows an example of advanced weekly program for the given lawn:
 - On Monday and Tuesday, Robomow mows the large area of 250m² (entry point is the Base Station); it starts at 13:00 for 'MAX' operating time, where on Monday it mows the edge before entering to mow the inner area (Mode: E+M, means edge + mowing of the inner area);
 - On Wednesday, Robomow mows the small area of 50m² (entry point is Entry 1); It starts at 15:30 for 1:30 hours; Robomow follows the wire towards entry point 1 without mowing the edge, as the edge was mowed on Monday (there is no need to mow the edge more than twice a week);
 - Thursday to Saturday contain the same mowing cycle as defined on Monday to Wednesday in order to mow all the area twice a week, which is required during the fast growing season.



▪ Display program

The weekly program display (figure 2.7) is used to show additional information about the last week operations except of the '+' for the active days.

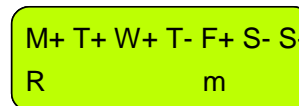

Shortcut buttons

To display the program, press the '**UP**' arrow while Robomow is in the Base Station. The program is displayed for 10 seconds before changing back to the main display.

To update the program, press the '**GO**' button within the 10 seconds that the program is displayed.

The following characters may appear under each of the active days:

| Character | Meaning |
|-----------|---|
| + | Active day |
| B | Skipped due to low battery voltage; (Robomow did not depart from the Base Station at the scheduled time due to low battery voltage) |
| b | Docked before time due to low battery voltage; (Robomow did not complete the operation and drove back to the Base Station due to low battery voltage – relevant only when ' Work time ' different from ' Max ' is set) |
| d | Robomow did not return to the Base Station because of Drive over current (' Start elsewhere ') or ' Drive problem '; Robomow returned to the Base Station before time due to drive overheat. |
| M | Skipped due to mow over current detected in the Base Station before Robomow has started the operation. |
| m | Robomow returned to the Base Station before time due to mow problem (over current or over heat) |
| O | Skipped because the mower was out of the Base Station at the scheduled start time |
| P | Skipped due to power problem (there is no charging voltage at departure time) |
| R | Skipped due to rain; (Robomow did not depart from the Base Station at the scheduled time due to rain detection) |
| r | Docked before time due to rain; (Robomow did not complete the operation and drove back to the Base Station due to rain detection during the operation) |
| S | Skipped due to signal problem (it may happened because of problem with wire sensors, cut perimeter wire, poor splicing of perimeter wire or perimeter wire which was too long). |
| s | Robomow returned to the base because of no signal for more than 1 hr |
| U | Skipped due to user choice/interference (usually ' skip next start ' or when the ' Program ' set to ' off ') |
| u | Robomow did not return automatically to the Base Station because of user interference |

How to cancel an active day?

In weekly program set by days, simply change the '+' to '-' in the main display of the days; in the '**Advanced**' weekly program, choose the '**None**' option under weekly program menu in the '**Mode**' display.

2.1.1.2 Entry points

'**Entry points**' are defined as the points, where the mower leaves the Edge and turns into the lawn to mow the inner area. The default of the '**Entry points**' is set to '**off**' in the factory; it means that all operations of the inner area will start from the Base Station.

The '**Entry points**' menu consists of two options (figure 2.8):

Set entry points – Allows setting up to four different entry points to your lawn in addition to the Base Station, which is defined as an entry point by default. It is recommended to '**Set entry points**' where there are narrow passes in order to insure the mower will cover all areas effectively.

To set the entry points, choose this option when the mower is in the Base Station; Robomow will start to follow the perimeter wire; follow the mower and press '**GO**' at the point you want to set; press '**GO**' for other points or press '**STOP**' to end the process.

Entry points on/off – Allows user not to use the entry points. When setting the **'Entry points'** to **'off'** the mower will always start the mowing the inner area from the Base Station.



Figure 2.8
Entry points

When using weekly program by area or by days, the entry points are used in a cyclic mode i.e. Robomow will start at a different entry point every operation, in a cyclic mode.

When using the advanced weekly program, the user has the option to set any entry point he wants per day.

- Notes:**
1. It is not necessary to set all 4 points, if you find that 2 or 3 points are enough to your lawn, you can stop the mower at any time during the process.
 2. There is no need to wait until the mower will complete the drive back to the Base Station; you can stop the mower at any time you want during the **'Set entry points'** process by pressing the **'STOP'** button.
 3. Manual start - Upon pressing the **'GO'** button for manual start, you will be asked to select the entry point, if you have set them previously.

2.1.1.3 Skip next start

The **'Skip next start'** option allows user to skip the next scheduled operation (figure 2.9).

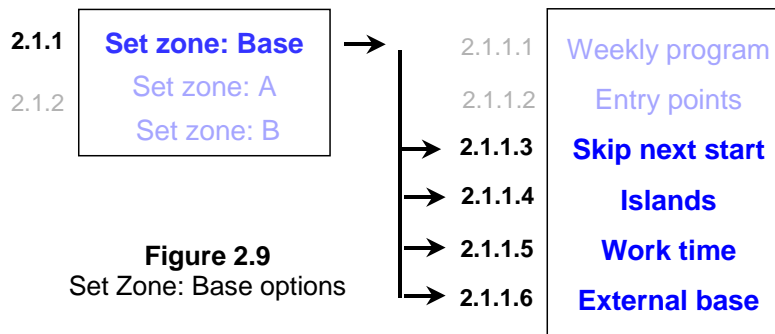

Figure 2.9
Set Zone: Base options

There are two options to activate this option:

1. **Shortcut** – when the mower is in the Base Station press the **'STOP'** key first to display the right display (figure 2.10).

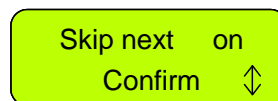

Figure 2.10
Skip next start

Then press **'GO'** to confirm the skip.

2. Under **'Set Zone: Base'** menu scroll to **'Skip next start'** option and press **'GO'** to set the option (see figure 2.9).

After setting the **'Skip next start'** option to **'on'** the mower will display the next start time after the one skipped.

2.1.1.4 Island

Setting this option to **'off'** allows the mower to acquire the Perimeter Wire immediately as starting to search for the Base Station with no need to converge to the end of the lawn (figure 2.9).

2.1.1.5 Work time

- Allows the user the option of setting the operating time from the **'MAX'** default setting to times ranging from 15 minutes up to 2:00 hours (figure 2.11).
- This menu is used when operating the mower in Manual Start from the Base Station, as when the mower departs automatic from the Base Station, the **'Work time'** it used is as defined in the weekly program.

- The **'Work time'** is set per zone, allowing you to set different operating time for several different zones that are of varying sizes.
- The **'Advanced'** weekly program allows to set different work time per operation (refer to **'Advanced weekly program'** in paragraph 2.1.1.1).

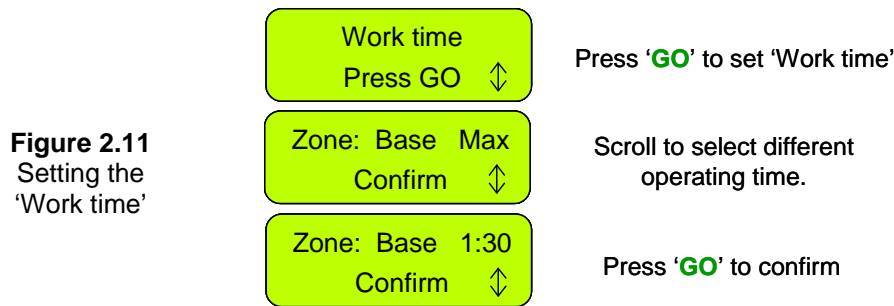

2.1.1.6 External Base

- Allows the option to setup the Base Station outside the lawn; recommended when you want to conceal the mower from people eyes while not mowing.
- The default set by the producer is set to 'off'; if you setup Robomow outside the lawn it is required to change the setting of 'External base' to 'on'.
- The mower follows the wire for 5m (15ft) from the Base Station before it enters to mow the inner area, thus it is recommended to set the Base Station at maximum 3-4m (10-13ft) from the lawn; however if you want to set the mower in a bigger distance from the lawn, you have to increase the 'Distance' setting (in the 'External base' menu) respectively.
- To perform external setup of the Base Station refer to paragraph 1.3.2.

2.1.2 Set zone: A (or B)

Allows user to set the parameters that are specific per non-Base Station zone (figure 2.13):

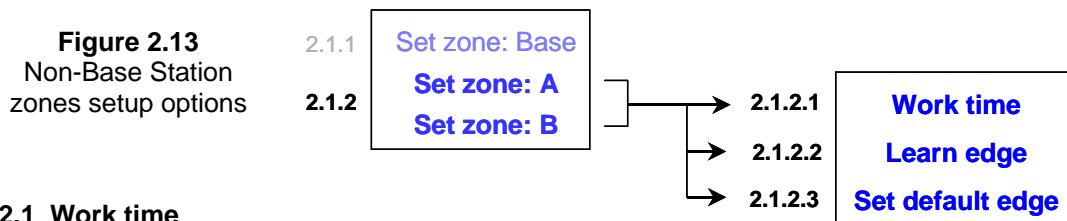

2.1.2.1 Work time

Allows the user the option of setting the operating time from 15 minutes up to 2 hours and **'MAX'** which is generally 2.5 to 3.5 hours, depending on grass type and condition.

2.1.2.2 Learn Edge

This menu option is used in a non-Base zone only. The default distance for edge mowing is approximately 1 to 2 rounds around the perimeter. This feature allows the user to define a specific distance in each operating zone in order to have the mower cut the edge at a specific distance. It will remain as a learned distance until the edge is re-learned or the **'Set default edge'** is selected. To learn edge distance follow the instructions below (figure 2.14):

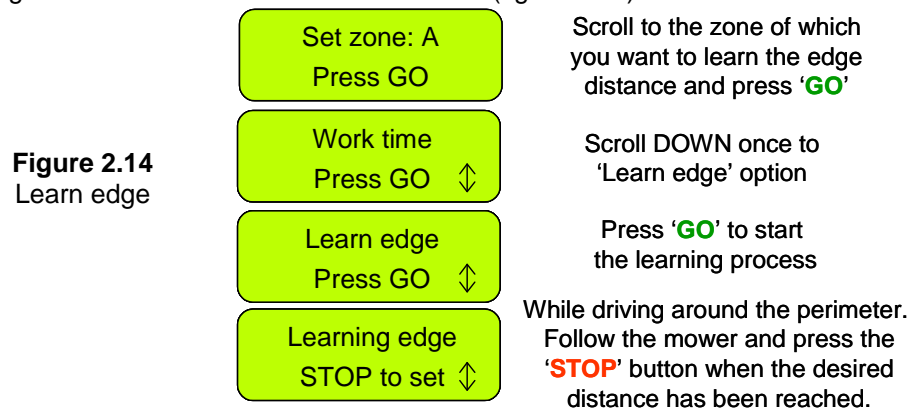

2.1.2.3 Set Default Edge

Selecting Default Edge restores the factory default edge distance to the specific zone selected.

2.2 Settings

The **'Settings'** menu allows the user to set the **options that refer to the Robomow itself** and are common to all zones (figure 2.1).

2.2.1 Child Guard

Child guard is a feature that when activated will help deter use by young children and other unauthorized people. It will prevent operation to those not familiar with the mower. The key sequence to unlock the guard for operation is pressing the **'UP'** arrow key and then the **'STOP'** key to unlock the controls. Two minutes of inactivity will re-lock the keys.

It is strongly recommended to use the "Child Guard" menu option in order to prevent operation by children or others who are not familiar with the safe operation of the Robomow.

2.2.2 Anti-Theft

The anti-theft system provides the user a disabling function that will prevent anyone from using or driving the Robomow unless they have the valid code to enter. You will be prompted to enter a four-digit code of your choice to use as your personal security code. Use the scroll arrows in order to change each digit position to a different number and then press **'GO'** to move to the next digit to select. You will find a place to record your personal security code in Chapter 8 of this manual. Be sure to record your code for future reference.

To change the password, choose the **'Change code'** option under the **'Anti theft'** menu. You will be promoted to enter your old password before setting the new one.

2.2.3 Time And Date

Allows setting time and date (figure 2.15):

Figure 2.15
Time and date

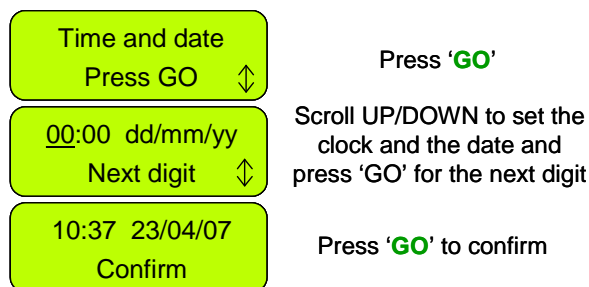

2.2.4 Rain Sensor

The Rain sensor feature enables the mower to detect rain and skip or stop the operation as it is detected. There are three options under the **'Rain sensor'** menu, as shown in Figure 2.16:

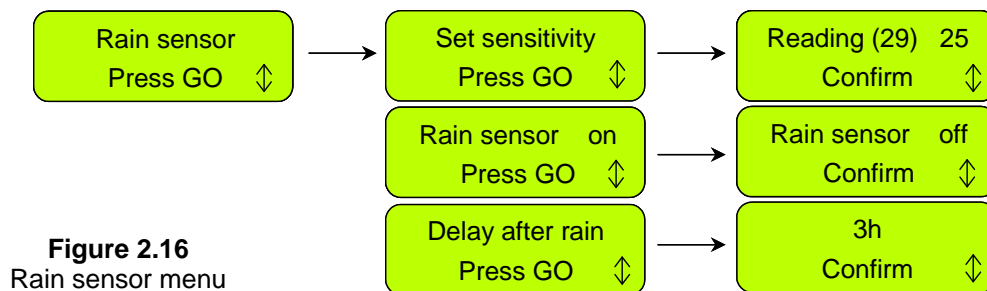

Figure 2.16
Rain sensor menu

- **Set sensitivity** – Enables to set the sensitivity of the rain sensor in which the mower will detect rain below the threshold set. The default sensitivity set in the factory is 25, it means that in any reading below 25 the mower will detect rain and will not operate. The number in the brackets shows the actual reading of the rain sensor.
- **Rain sensor on/off** - Allows turning the rain sensor feature off to enable operation in rain and wet grass conditions.
- **Delay after rain** – Enables to set time delay, in case that rain is detected by the mower before the start time, in order to let the grass dry before the mowing is starting. **For example**, if the scheduled start time is 13:00, the **'delay after rain'** was set to 5 hours and the rain has stopped 2 hours before the scheduled start time (11:00), then the Robomow will delay the start time of the operation and will start at 16:00 (5 hours after the rain was stopped, which is 3 hours after the scheduled start time). The default 'delay after rain' set in the factory is 0 hours.

2.2.5 Language

Allows the user the option of viewing the LCD text in several different language versions.

2.2.6 ECO Mode

The ECO (Economic) mode feature enables operating Robomow using minimum energy required to cut the grass and maintain the lawn. The ECO mode default is set to 'on'. Operation in ECO mode reduces Robomow noise level during operation and allows longer operation time. It is recommended to use the ECO mode only in zones with Base Station, where mowing is more frequent and a shorter part of the grass is cut. If Robomow detects high grass it will automatically increase the power of the mowing motor to enable cutting higher grass.

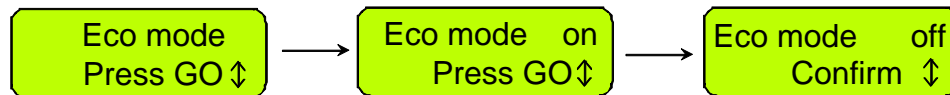

2.2.7 Signal type

In some circumstances there may be interference to the wire signal caused by other wire signal activated in adjacent lawn (neighbor that use robotic lawnmower) or by any other appliance using similar

frequency. In case of signal interference, you may see one of the following symptoms (usually close to

the neighbor lawn):

- a. Robomow is widely swinging when driving along the wire;
- b. Robomow changes direction without reaching the wire;
- c. Robomow crosses the wire outside the designated area;
- d. 'Start inside' message is displayed although Robomow is inside the designated area and the perimeter wire is connected in the right polarity;

If your mower faced one of the above symptoms, to change the signal type call to service

2.2.8 Blade Replaced

Choose this option after replacing the blade to restart the reminder counter. A reminder to replace the blade again will be displayed after the next 200 hours of operation. Blade is easy to replace, refer to section 5.5.

2.2.9 Wire Position

Allows user to test the wire position in '**Edge**' mode while the mowing motors are switched off to prevent any damage to the perimeter wire after the initial setup of the wire is completed.

2.2.10 Delay operation

This option allows the user to press GO but delay the operation starting time. It is useful when you want to start the operation later in the day when the grass is dry and not early in the morning when the grass is wet (and you have to leave for work).

To use this option, follow the steps below:

- Set the 'Delay operation' to X hours (choose between 1,2,3...or up to 8 hours);
- Switch on the Perimeter Switch (It is operated for 12 hours) and place the mower inside the lawn towards the perimeter wire;
- Pressing 'STOP' then 'GO' (while holding the 'STOP' button) will change the display to 'Press GO again to skip edge' and at the end of the warming up process, the mower will stay in place with a message 'Operation delayed – wait...'
- The mower will start the operation after X hours (as set in the 'Delay operation' menu) from the 'GO' pressing.

2.3 Information

The '**Information**' display (refer to figure 2.1) is used for information only, it allows the option to scroll between the following menus:

2.3.1 Operation

Total time - Indicates the total number of hours the mower has been in operation.

First operation - Indicates the date, in which the mower was first operated.

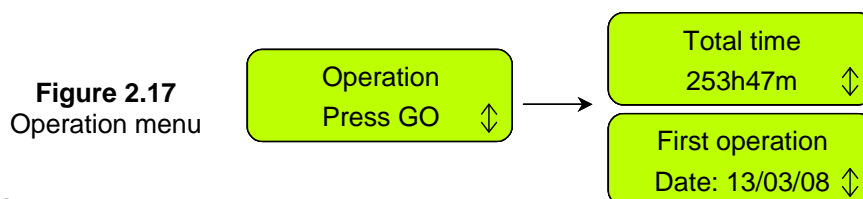

2.3.2 Battery

Battery voltage - Displays the current voltage of the batteries.

Last run times - Indicates the last battery run time in the last 10 operations, the voltage at the beginning of the operation and the operation date.

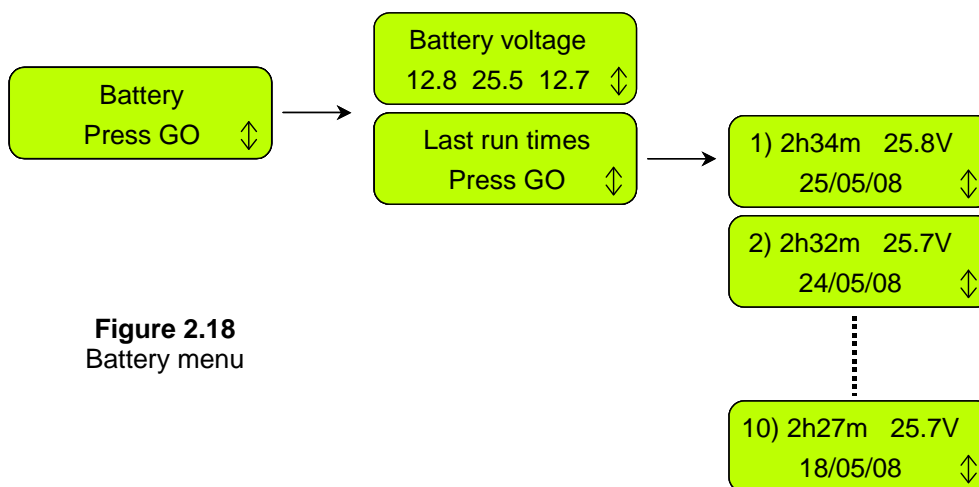

2.2.11 Temperatures

Displays the temperatures on the drive motors, mowing motor and on the Main Board.

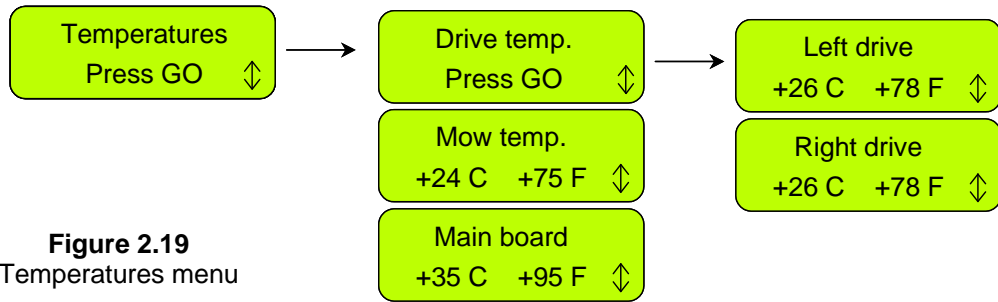

Figure 2.19
Temperatures menu

2.3.2 Configuration

Displays the configuration of the Robomow: Main Board part number, software version and Base Station Board part number (figure 2.20):

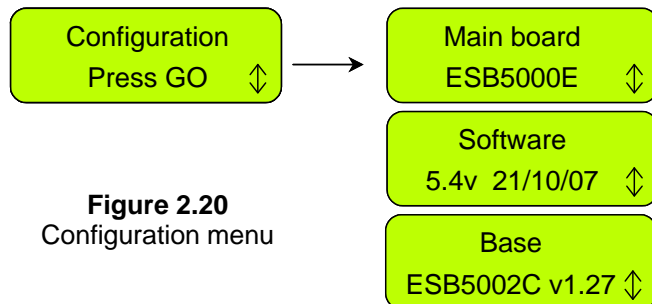

Figure 2.20
Configuration menu

2.3.3 Last stop causes

Displays the last ten stop causes number and the date of the stop.

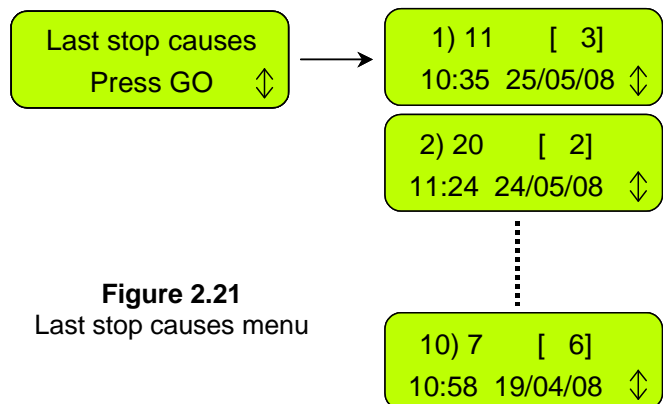

Figure 2.21
Last stop causes menu

Chapter 3 – Operation and Charging

3.1 Edge Mowing

The first mowing chore for Robomow is mowing the edge. Edge is the outer perimeter of the active zone Robomow is working within. This is essential where you placed your perimeter wire in the wire set-up.

Edge mowing provides a clean even cut around the perimeter and helps to minimize the amount of trimming along walls and other obstacles.

Edge in Base Station Zone –

- Robomow leaves the Base Station (at the scheduled time or when pressing the '**GO**' button once) to mow the edge of the lawn. It will make exactly one turn until it reaches the Base Station contacts;
- It will reverse out and move back to continue mowing the inner area of your lawn (see paragraph 3.2).

Edge in None-Base Zone –

- Place Robomow inside the lawn, switch on the Perimeter Switch on and press the '**GO**' button once;
- Robomow will automatically find the edge (perimeter). It will now begin mowing the edge, completing one to two complete passes around the perimeter and then turn into the lawn to mow the inner area of the lawn;
- It will then drive into the lawn and begin what is called the scanning process (see paragraph 3.2).

3.2 Scanning (Mowing of the inner area)

The scanning process is simply a process whereby Robomow is moving across your lawn while it is mowing.

Robomow's movement pattern is irregular with combination of parallel lines in narrow passes. Keep in mind that the Robomow will not mow all the grass on its first pass; in fact it will leave uncut grass in between many of the passes it makes. This is expected and is entirely normal. These uncut areas will be cut on subsequent passes of the Robomow across the lawn. Just like a dishwasher, wait until the job is finished before you can appreciate the results.

Robomow will continue to run for the amount of time selected or for the default '**MAX**' time, which is generally 2.5 hours, depending on grass type and condition.

3.3 Skipping Edge Mowing

Robomow provides a means that will allow you to skip the edge mowing process and start directly with the scanning (mowing) process. In order to do this, simply press the '**GO**' button twice at the initial startup of the mower. Pressing '**GO**' the second time immediately following the first press will tell the mower to skip mowing the edge.

To skip the edge mowing in the '**Advanced weekly program**' set the operation mode to '**M**' (where '**M**' is for 'mowing' the inner area only and '**E+M**' is for 'edge + mowing' of the inner area).

3.4 Operation in Base Zone – Automatic Start

- Automatic Start mode is used as a fully automatic solution to maintain your lawn.
- This mode enables you to set a weekly program, and the mower will automatically start to mow and drive back for charging at the Base Station when finished.
- To set the weekly program refer to Chapter 2.1.1, '**Set Zone: Base**'.

WARNING!



Never let Robomow operate without supervision. Serious injury can occur. Insure that the scheduled operating times that you program in for automatic start and mowing are times when the mowing area will be free of children and pets. Do not program times unless you are certain the area will be free of children, pets and bystanders.

3.5 Operation in Base Zone – Manual Start

Manual Depart mode can be used in cases such as the following:

- Mowing the lawn at times other than when programmed.
- When the lawn is occupied and the yard must be cleared of debris, objects, pets or people first.
- For initiating a manual start for mowing, press the **'GO'** button **once** to start the sequence:
 1. If entry points were set (see 2.1.1.2), you will be asked to select the entry point for the current operation.
 2. Robomow will depart from the Base Station and will mow the edge until it reaches the Base Station. It will reverse out and move back to continue mowing of the inner area.
 3. Robomow will follow the perimeter wire towards the entry point. A **'Searching entry'** message is displayed on the display while it is searching for the entry point into the lawn.
- To skip the edge mowing process, press the **'GO'** button **twice** when initiating manual start and mowing.

3.6 Returning to the Base Station

- Automatic Return
Robomow automatically returns to the Base Station at the end of every operation. It will recharge and stay ready for the next scheduled start time that was scheduled.
- **'Go to base'** option
You can manually send the mower to the Base Station from any point in the lawn by pressing the upper scroll arrow once for the **'Go to base'** message option - then press **'GO'**. The Robomow will find the perimeter wire and will follow it until reaching the Base Station – **'Searching base'** message is displayed during this sequence.

3.7 Operation In None-Base Zone

Non-Base Zone is defined as a separated area, where the user must drive the mower manually from the Base Station or carry it by hand, to the area in order to mow it. It can be operated either by the Perimeter Switch or the Base Station.

Important! When mowing in non-Base zone, it is required first to define the non-Base zone (refer to section 2.1.2 **'Set Zone: Base'**).

- **Zone activation**
Connected to the Base Station - the zone is activated automatically as the mower is taken out from the Base Station. If an intermittent beeping is heard shortly after turning the switch on, there is a problem of cut wire or poor wire splicing (refer to chapter 4 – Text messages and Troubleshooting for further help). Listen to the beeps to identify the problem (refer to figure 1.24). You must correct the problem before Robomow can operate automatically.
Connected to Perimeter Switch - Robomow cannot operate unless the Perimeter Switch is turned on. Press the **on/off** button to turn on the switch. To verify switch operation, there is a green LED located next to the button that will flash when operating properly. If an intermittent beeping is heard shortly after turning the switch on, there is a problem of cut wire or poor wire splicing (refer to chapter 4 – Text messages and Troubleshooting for further help). Look to see which of the red LEDs is flashing to identify the problem (refer to figure 1.43). You must correct the problem before Robomow can operate automatically.
- Place the mower inside the active perimeter.
- Press the **'Down'** scroll arrow to receive the display of the zone to be mowed (Zone A or B) and press the **'GO'** button. In a case where you have forgotten to turn on the Perimeter Switch, a 'No wire signal' message will be displayed, reminding you to turn the switch on.

3.8 Completing the Operation

Base Station Zone –

When Robomow has operated the allotted time, it will switch off the mowing motor and will start moving in lines towards one of the lawn edges, then it will follow the perimeter wire back to the Base Station, to be charged and get ready for the next operation.

Non-Base Station Zone –

- When Robomow has operated the allotted time, it will simply stop in the lawn, waiting for you to drive it back to the Base Station. The LCD will display a '**Recharge battery**' message if the mowing time is set to '**MAX**' or '**Time completed**' if the mowing time has been set to any time other than '**MAX**'.
- If Robomow has completed its mowing and it is more than 15 minutes before you arrive to move it, the LCD screen will be blank. Robomow will shut itself down into a sleep mode after 15 minutes of inactivity at all times. This is an energy saving feature. Pressing the '**GO**' button will wake it up and display the message that was on the LCD when it went into sleep mode.

3.9 Charging

Robomow is supplied with two power supplies:

1. Base Station Charger –

- It is connected between the Base Station and a 230V/120V wall socket. It is connected to the wall socket via an integrated power cord and to the Base Station via a 15m / 50ft long low voltage cable (the length of the low voltage cable must not be lengthened).
- It is approved for outdoor use.
- The charging time is approximately 20 hours, depending on conditions.
- When the mower is in the Base Station the battery is charged and one of the following screens is displayed:

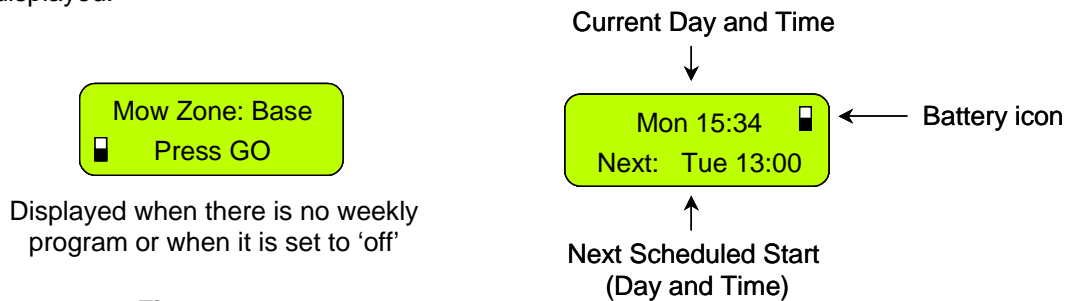

Figure 3.1
Charging in the Base Station

Displayed when a program is set

- The charging system and battery are designed to remain plugged in at all times of non-use, throughout the mowing season, without concern to over charging, over heating or damaging the battery.

2. Winter Charger -

- During long period, such as winter, when Robomow is not in use, it is recommended to clean Robomow and connect it to charging using the winter charger to all the period it is not in use (refer to paragraph 5.7 – Winter Storage).
- The winter Charger is an integrated part of the Robomow and it is designed for **indoor dry use only**. Do not charge Robomow where wet contact is likely.
- Never connect the winter charger while Robomow is still in the Base Station.
- The charging time is approximately 48 hours when using the winter charger.
- When connecting the charger the following message (figure 3.2) will be displayed and the battery icon will continually move from empty to full to show the charging.
- Once the battery is fully charged, the message will change to that as shown in Figure 3.3, reminding you to keep it connected to the charger until the next use.

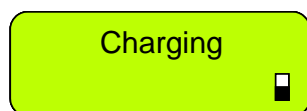

Figure 3.2
LCD display during charging process

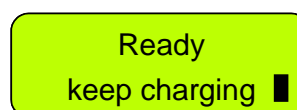

Figure 3.3
LCD display during while battery if fully charged

Chapter 4 - Text Messages and Troubleshooting

4.1 Messaging

Robomow is equipped with an LCD panel that will notify you in the form of a text message when common operational faults occur to instruct the user to perform a certain function or action.

If the LCD screen is blank, pressing the '**GO**' button one time will wake the mower up and the last fault or message displayed prior to stopping will now be displayed. If a specific problem re-occurs, it is recommended to identify the fault code prior to calling for service. Pressing the '**UP**' arrow once, while the message is displayed, is a shortcut button to display the '**Last stop cause**' (refer to paragraph 2.3.5).

| Message Displayed | Probable Cause/Event | Corrective/User Action |
|--------------------------------|--|--|
| Adjust wire then press GO | - Robomow detects an obstacle along the edge while operated in ' <i>Wire position test</i> ' mode. | - Adjust the wire in the place where it collides in the obstacle or remove the obstacle and then press 'GO' to continue in the wire position test. |
| Alarm will be soon activated | - The 'Theft guard' system is activated, but the 4 digits code was not entered; the mower will start the alarm soon. | - Enter the correct 4-digits code. |
| Base problem | - Robomow fails to enter the Base Station 3 times continuously | - Adjust the Base Station position. - Clean the contacts with a brush or piece of cloth. - Confirm a good connection of the cables to the Base Station contacts. - Confirm the Base Station is leveled with the ground before the Base, so there is no step that causes Robomow to slips. |
| Bumper pressed | - Bumper is constantly being pressed | - Move mower away from object pressing against bumper. |
| Change wires in plot connector | - This message appeared at the first time the 'GO' button is pressed after completing the setup in case the perimeter wire is connected to the plot connector in the wrong polarity. | - Change between the two wires ends that connected to the plot connector (the green connector that connected to the Base Station). |
| Charging failure | - The charging process is not active | - Contact service provider |
| Check mow height | - Mowing motor has faced over-current for too long because of high grass or some obstacle is stuck or wrapped around the blade. - Something is preventing a blade from rotating freely. Severe grass accumulation under the mowing deck; rope or similar object wrapped around mowing blade. - Object jammed under mower preventing blade from rotating. | CAUTION – Remove fuse before lifting the mower. - Inspect blades for foreign material or debris preventing rotation. - Clean out accumulated grass clippings using a wooden stick. |
| Check power (Base Station) | - Power supply is not plugged properly into the main power supply - The charging process has stopped due to a temporary power loss. | - Confirm power supply is plugged into the main power receptacle. |
| | - No power to receptacle or main power is shut off | - Turn power on to the main receptacle. - Check the mains supply using another appliance |
| | - The mower or Charging Station contacts are dirty | - Clean the contacts with a brush or piece of cloth |
| | - Charging is not detected, although there is physical contact between the mower and the Base Station contacts. | - Confirm a good connection of the power supply to the Base Station. - Confirm a good connection of the Base Station board cables (green and red) to the Base Station contacts pins (screws are tightened). |

| Message Displayed | Probable Cause/Event | Corrective/User Action |
|------------------------------------|--|--|
| Check power (Winter charger) | - Power supply cable is not plugged properly into the mains supply. | - Confirm power supply is plugged into the main power receptacle. |
| | - No power to receptacle or main power is shut off | - Turn power on to the main receptacle. - Check the mains supply using another appliance |
| Check signal Press GO | <ul style="list-style-type: none"> - There is no fitting between the 'Signal type' setting in the menu and the signal jumper on the Perimeter Switch; - Automatic operation is initiated while Robomow is placed out of the perimeter wire lope. - The perimeter wire is connected to the plot connector in the wrong polarity. - Robomow detects signal interferences from adjacent activated lawn or from other appliance activated near the zone; | <ul style="list-style-type: none"> - Set the 'Signal type' menu to 'A' and confirm the signal jumper is installed on the Perimeter Switch board; or alternatively set it to 'B' and remove the signal jumper from the board; - Place the mower inside the lawn and press the 'GO' button. - Change between the two wires ends that connected to the plot connector (the green connector that connected to the Base Station). - In case of signal interference call the service for help; |
| Check wire | <ul style="list-style-type: none"> - Poor connection of perimeter wire - twisted cables, or a screw terminal, insulated with insulation tape is not a satisfactory splice. Soil moisture will cause the conductors to oxidize and after a while result in broken circuit. - Too long perimeter wire | <ul style="list-style-type: none"> - Check and repair all loose/poor or corroded connections. - Use only the connectors supplied in the box. It is waterproof and gives a reliable electrical connection. - The maximum length of wire allowed in one lope is 500m – if the wire is longer than 500m, split the area into 2 separated zones. |
| Close cover | <ul style="list-style-type: none"> - The bumper cover is not in its place because one of the following reasons: <ol style="list-style-type: none"> 1. The cover has popped out during operation while Robomow has collided in obstacle. 2. The bumper cover was not placed properly by the user in its place. | <ol style="list-style-type: none"> 1. In case of short / slanted obstacles, it must be protected from the Robomow using the perimeter wire around it. 2. Press the bumper cover downwards and confirm it is clicked well. |
| Cross wire | <ul style="list-style-type: none"> - The perimeter wire is too close to the edge - The lawn slope is too big - Robomow does not succeed to turn in place at the edge and it causes the mower to slip out of the area. - Too low cutting height for the lawn and grass conditions. | <ul style="list-style-type: none"> - Remove the wire towards the inner side of the lawn and do not include area with too big slopes. - Fill any holes and pits in the ground. - Increase the cutting height |
| Drive overheat cooling, wait... | - The drive motors have been working under a severe load for too long. | - There is no need to do anything Robomow will renew automatically the operation, as the drive motor will cool down. |
| | - Short-circuit detected in Drive Motors. | - Contact your Service Dealer. |
| Enter code | - The theft guard system is activated | - Enter the correct 4-digit code. 'Theft Guard' can be deactivated under 'Settings'. Contact your service provider for assistance in a lost code situation. |
| Failure: xyz | - Internal failure | - Press 'go' to confirm the message; if the message is still displayed, remove the battery fuse for 10 seconds and retry to operate the mower. If the message still displayed, contact your service dealer. |

| Message Displayed | Probable Cause/Event | Corrective/User Action |
|-------------------------------|---|---|
| Frnt wheel prob | - The Front Wheel has left the ground for more than 8 – 10 seconds. | CAUTION – Remove battery fuse before lifting the mower |
| | | - The Robomow has driven onto an obstacle, raising the front end. Remove or exclude this object from the mowing area. |
| | | - The Robomow is being used on a slope too steep for safe mowing. Exclude this from the mowing area. |
| | | - High grass is preventing the front wheel from fully riding on the ground. Raise the cutting height. |
| | | - The ground contains large holes or indentions where the front wheel can drop into when passing across. Fill these areas with dirt and level off. |
| High temperature waiting... | - Robomow is charged through the Base Station and the ambience temperature is out of range (above 158°F / 70°C); | - Do not do anything, the charging is stopped and Robomow is waiting for temperature to change back to the allowed range; if temperature stays out of the range for more than 12 hours, the message is changed to ' <i>High temp. Press GO</i> '. |
| Insert fuse for charging | - Robomow is connected to charging without a battery fuse | - Disconnect Robomow from charging, insert the battery fuse and reconnect to charging. |
| Keep charging if not used | - Message is displayed every time the power supply is disconnected. - Displayed when the mower isn't in operation and not connected to the charging for a long time. | - Press any key to change the display back. - Send the mower back to the Base Station for charging / connect the power supply or continue in operation. |
| Key pressed | - One of the operating panel buttons is constantly pressed. | - Press 'GO' to confirm the message and to continue in operation. The message is displayed to inform the user about the problem, but will not prevent the operation. |
| Keys locked | - Child lock feature has been activated | - Press the <i>Up</i> ↗ arrow key and then press the ' <i>STOP</i> ' button. Child lock can be deactivated under the ' <i>Settings</i> ' menu. |
| Low battery | - Mower is searching for the Base Station but the battery voltage is too low to continue the searching process. | - Drive the mower manually using the remote control or carry it by hand for charging in the Base Station. |
| | - Robomow has skipped the last start time due to low battery voltage | - Confirm there is enough time between the two adjacent departures so the battery can be charged prior the scheduled operation (min 16 hours between operations) |
| Low temperature waiting... | - Robomow is charged through the Base Station and the ambience temperature is out of range (below 32°F / 0°C); | - Do not do anything, the charging is stopped and Robomow is waiting for temperature to change back to the allowed range; if temperature stays out of the range for more than 12 hours, the message is changed to ' <i>Low temp. Press GO</i> '. |
| Mow overheat cooling, wait... | - The mowing motor has been working under a severe load for too long of a time. | - There is no need to do anything – Robomow will renew automatically the operation, as the mowing motor will cool down. |

| Message Displayed | Probable Cause/Event | Corrective/User Action |
|-------------------------------|--|---|
| No wire signal | <ul style="list-style-type: none"> - Base Station / Perimeter Switch is not turned on or not connected to the zone intended to mow. - The perimeter wire is not connected to the Base Station / Perimeter Switch - The perimeter wire is cut | <ul style="list-style-type: none"> - Make sure the Base Station is connected to the mains supply - Disconnect the Base Station power supply from the mains power and reconnect after 10 seconds. - Check the Perimeter Switch is connected to the correct zone and is turned on. - Check the connection of the perimeter wire to the Base Station / Perimeter Switch. - Check for cut in the perimeter wire. |
| Peg base then press GO | <ul style="list-style-type: none"> - This message is displayed after 'Base position' test is completed successfully. | <ul style="list-style-type: none"> - Fasten the base in place using the 2 stakes (figure 1.30). |
| Rain detected GO to ignore | <ul style="list-style-type: none"> - Robomow detects rain upon GO pressing (received when pressing the GO button) | <ul style="list-style-type: none"> - Do not operate Robomow in rainy weather and wet grass; If you choose to override, press the 'GO' button; The overriding is valid for the current operation only |
| Rain detected Press GO | <ul style="list-style-type: none"> - Robomow has skipped the last depart due to rain detection | <ul style="list-style-type: none"> - It is not recommended to cut wet or damp grass, but if you choose to override the rain sensor, change the setting of the 'Rain sensor' to 'off' under the 'Settings' menu. |
| Rain detected start delayed | <ul style="list-style-type: none"> - The operation is delayed as Robomow detects rain on the scheduled time it should start the automatic operation from the Base Station. | <ul style="list-style-type: none"> - Do not do anything; the message is displayed until the Robomow will not detect rain for x hours (as defined in the 'Delay after rain' menu). |
| Rain sensor disconnected | <ul style="list-style-type: none"> - Disconnection in the rain sensor wires. | <ul style="list-style-type: none"> - Press 'GO' to confirm |
| Ready keep charging | <ul style="list-style-type: none"> - The battery is fully charged (displayed when charging through the standard power supply and not through the Base Station) | <ul style="list-style-type: none"> - Keep the charger (power supply) connected and operating |
| Recharge battery | <ul style="list-style-type: none"> - The maximum operating time has been reached (displayed in non-Base Station zone) | <ul style="list-style-type: none"> - Connect the charger to the mower |
| Remove fuse before lifting | <ul style="list-style-type: none"> - Robomow was lifted while the battery fuse is connected. | <ul style="list-style-type: none"> - Remove the fuse before lifting Robomow. |
| Remove fuse then check blade | <ul style="list-style-type: none"> - Some obstacle is stuck or wrapped around the blade. - Something is preventing a blade from rotating freely. Severe grass accumulation under the mowing deck; rope or similar object wrapped around mowing blade. - Object jammed under mower preventing blade from rotating. | <ul style="list-style-type: none"> - CAUTION – Remove battery fuse before lifting the mower. - Inspect blades for foreign material or debris preventing rotation. - Clean out accumulated grass clippings using a wooden stick. |
| Replace blade every 200 hours | <ul style="list-style-type: none"> - An automatic reminder to replace the blades is displayed every 200 hours | <ul style="list-style-type: none"> - Replace the blades and restart the counter of the blades replacement reminder by choosing the 'Blades replaced – Clear reminder' option under the 'Settings' menu |
| Reposition base | <ul style="list-style-type: none"> - Robomow fails to enter the Base Station during 'Base position' test | <ul style="list-style-type: none"> - Reposition the Base Station; usually it should be placed with the marked lines on the Base aligned with the perimeter wire. If the Base is placed in narrow pass, where the distance from the adjacent wire is less than 3 meters, the Base Station should be placed in shift of few cm towards out of the lawn. |

| Message Displayed | Probable Cause/Event | Corrective/User Action |
|---|--|--|
| Splice wire (Confirm the Base Station beeps continuously for cut wire) | <ul style="list-style-type: none"> - Perimeter wire cut - Wire disconnected from the Base Station / Perimeter Switch | <ul style="list-style-type: none"> - Confirm wire is plugged in and wire leads are firmly attached. - Walk along perimeter, including islands and look for obvious cuts or break in the wire. Repair with Robomow wire splice connectors. - In case the wire cut is not visible call your service dealer for more information how to find the wire cut. |
| Start elsewhere | - An unknown fault has occurred and user help is required | - Manually drive/carry the mower away from this particular area and restart operation. |
| | - Drive wheel motors have been working under a severe load during automatic or manual operation. | <ul style="list-style-type: none"> - Check to insure the mower is not stuck, allowing the drive wheels to slip. - Check the ground for holes or indentions, where the mower has stopped and fill it with dirt and level off. - Check the drive wheels are free to rotate and nothing block them. - Remove the mower away from this particular point and restart operation. |
| Start inside | - Automatic operation is initiated while Robomow is placed out of the perimeter wire lope. | - Place the mower inside the lawn and press the 'GO' button. |
| Stuck in place | - Robomow get stuck in place with no succeed to continue driving. | - Check the ground for holes or indentions, where the mower has stopped and fill it with dirt and level off – especially in the area close to the perimeter, where the Robomow turns in place. |
| | - Robomow has difficulty to turn in place because the front wheel has fallen into hole or indention and it caused the mower to turn in place without detecting wire or bumper. | <ul style="list-style-type: none"> - Confirm the area is not too sloppy and make sure to work in dry condition. - Check the perimeter wire is not too close to the edge – remove if required. - Conform the mowing deck is not set too low. - There is an option to drive back to the lawn in reverse before Robomow perform the turn in place (contact your service dealer for details). |
| Switch off before lifting | - The user carries Robomow manually while the main switch button is on. | - Switch off the main switch button before carrying Robomow. |
| Switch off before lifting (While Robomow is in the Base Station) | - Robomow does not detect the power from the base Station, there is a charging problem | <ul style="list-style-type: none"> - Check the connection of the Base Station board cables (red and black) to the Base Station pins; confirm the screws are tightened. - Confirm good contact between Robomow and the Base Station charging pins. - Make sure the pins are clean and not corroded. |
| Time and date | - Displayed every time the batteries fuse is taken out of the mower (reset operation) | - Set real time clock (day and hour) and the date. |
| Time completed | - The operating time set for that zone has been reached. | - Connect to the charger if all mowing has been completed for the day. |
| Waiting for signal... | - Robomow has stopped the operation, because there is no signal detected. | <ul style="list-style-type: none"> - Check the power to the Base Station. - There is electrical power interruption. There is no need to do anything – Robomow will renew automatically the operation if the power will come back within an hour from the break; if the power will come back after more than one hour, Robomow will drive back to the Base Station for charging, but will not renew the operation and mowing. |

4.2 Other Operational or Fault Problems

| Problem Encountered | Probable Cause/Event | Corrective/User Action |
|--|--|---|
| Robomow operates at the wrong times | - Confirm that the time in the mower is set correctly (hour and date) | - Set the time (See paragraph 2.2.3) |
| | - The 'GO' button was pressed with no meaning, by someone or by a pet (' <i>Last stop cause</i> ' under the ' <i>Information</i> ' menu should be 805). | - To prevent unintended operation you can activate the ' <i>Child guard</i> ' or the ' <i>Anti theft</i> ' options, which requires pressing of few buttons in order to start the operation. |
| Robomow has skipped the scheduled operation | - Low battery voltage - Rain detected at the scheduled time - Some obstacle is stuck or wrapped around the blade prevent it rotating. - Signal problem | - In general, whenever Robomow does not start the operation at the scheduled time, the cause is recorded under ' <i>Program Display</i> ' (refer to end of 2.1.1.1 for more details). |
| | - User has chosen to skip the next operation | - No action is required |
| | - The program was set to ' <i>off</i> ' – the main display shows ' <i>Mow Zone: Base</i> ' and not the time and the next start details. | - Change the setting of the ' <i>Program</i> ' to ' <i>on</i> ' |
| ' <i>Cut wire</i> ' indicator flashing on Perimeter Switch or the Base Station beeps continuously for ' <i>Cut wire</i> ' | - Wire disconnected from perimeter switch or from the Base Station. | - Confirm wire is plugged in and wire leads are firmly attached. |
| | - Perimeter wire cut | - Walk along perimeter, including islands and look for obvious cuts or breaks in the wire. Repair with Robomow wire splice connectors. |
| | - Poor connections | - Check and repair all loose/poor or corroded connections. |
| ' <i>Poor connection</i> ' indicator flashing on Perimeter Switch or the Base Station beeps intermittently for poor wire splicing or too long wire | - Twisted cables, or a screw terminal, insulated with insulation tape is not a satisfactory splice. Soil moisture causes the conductors to oxidize and after a while result in broken circuit. | - Use the connectors supplied in the box. It is waterproof and gives a reliable electrical connection. |
| | - Perimeter wire too long for one zone | - A maximum perimeter wire length of 500 m is recommended. Areas requiring longer lengths should be broken into separate zones. |
| Robomow will not operate and nothing will display on the LCD screen. | - Mower is in deep sleep. | - If not connected to the Base Station/charger at all times when not in use, the Robomow will conserve power by entering into a deep sleep mode. Press the main switch button (on/off) 3 seconds continuously to wake Robomow or remove the fuse for 3 seconds. |
| | - Batteries have been discharged from lack of charge maintenance. | - It is required for the charger to remain connected to Robomow when not in use. Failure to do so can cause permanent damage to the batteries. Contact your service provider. |
| Robomow does not complete the edge in a non-base zone. | - Peculiar geometry of perimeter | - Perform ' <i>Learn Edge</i> ' (refer to 2.1.2.2). |

| Problem Encountered | Probable Cause/Event | Corrective/User Action |
|--|--|--|
| The Robomow is noisy and vibrates | - Damaged or unbalanced blade | <ul style="list-style-type: none"> - Check the lawn is free from branches, stones or other objects that can damage the blade before operating the Robomow. - Replace the blade |
| Poor quality of mowing (grass clippings are left on the lawn) or Uneven mowing results | - Grass is too high in relation to the set cutting height | <ul style="list-style-type: none"> - It is recommended to cut not more than a 1/3 of the green part of the grass. - Set the cutting height to a higher position - Use Robomow more frequently to maintain your lawn. |
| | - Grass is wet | - For best cut, operate Robomow when the grass is dry. It is recommended to mow grass early afternoon. |
| | - Dull blade | - Replace blade. |
| | - Robomow works too few operations per week | - Update the weekly program for more operations per week. |
| | - Working area is too large | - Limit the working area |
| LCD display is in a foreign language. | - The language setting was changed or not correctly set. | <ul style="list-style-type: none"> - Place the mower out of the Base Station and follow the sequence listed; - Press 'STOP' button few times to confirm it is on the main display - Press 'UP' ↑ button twice - Press 'GO' button once - Press 'Down' ↓ arrow button once - Press 'GO' button once - Press 'Down' ↓ arrow button 4 times - Press 'GO' button once - Using the arrow, scroll to the correct language - Press 'GO' to confirm this selection |
| Short run time, operates less time than normal | - Important! It is possible to see the last 10 battery run times and the battery voltage at the beginning of the operation in the 'Information' menu (refer to paragraph 2.3.2) | |
| | - Battery is not fully charged at the beginning of the operation | - Confirm the battery icon is fully and not changed (while charging in the Base Station) or 'Ready keep charging' message is displayed (while charging through power supply) prior the operation. |
| | - 'Work Time' for that zone is set to specific time and not to 'MAX' | - 'Work time' can be changed under 'Zones setup' menu |
| | - Grass is extremely over grown or very wet. | <ul style="list-style-type: none"> - Raise cutting height. - Always mow the grass frequently enough to prevent over growth. - CAUTION – Remove battery fuse before lifting the mower - Inspect blades for foreign material or debris preventing rotation. - Clean out accumulated grass clippings using a wooden stick. |
| | - Batteries are reaching a normal end of life state. | - Replace batteries. |

Chapter 5 - Maintenance and Storage

WARNING!



Serious injury can occur. Always remove batteries fuse before any maintenance or cleaning is done or before lifting Robomow. Blade is very sharp and can cause severe cuts or lacerations. Always wear heavy work gloves when working with and around the blade.



5.1 Recommended Maintenance Schedule

| Maintenance Service Interval | Maintenance Procedure |
|------------------------------|--|
| Regularly | <ul style="list-style-type: none"> ▪ Remove the batteries fuse and check any damage on the blade. ▪ Check and remove grass clippings and dirt from the mowing deck if necessary, particularly when mowing wet and damp grass (refer to section 5.2) ▪ Charge the Robomow batteries after every use. |
| 150 – 200 Hours | <ul style="list-style-type: none"> ▪ Replace the blade; replace it more frequently if the edges dull in rough or sandy conditions (see Figure 5.1). Remember to restart the automatic blade replacement reminder whenever the blade has been replaced (refer to section 2.2.6). |

5.2 Cleaning

Robomow and Base Station

Use only a damp cloth and a dry brush to clean the outer surfaces. A light detergent can be used in a water solution, and then soaking and wringing dry the cloth for cleaning. Never use harsh or abrasive cleaning solutions. Never spray with a garden hose or other type of liquid spray hose.

Mowing Deck

The underside of the mowing deck needs to be inspected, and cleaned if necessary, between operations. The Robomow is a dedicated mulching mower and may accumulate clippings under the mowing deck, particularly when mowing wet and damp grass.

Most grass accumulation can be removed using a small wooden stick or similar object. Carefully scrape the collected grass debris from under the mowing deck. If necessary, remove the blade to gain better access to the mowing chamber in order to clean it. Do not place the mower upside down, damage to the bumper can occur. Instead, lean it against another surface to gain access to the mowing deck area.

NEVER use a water hose or other type of liquid sprayer to clean the underside of the mower. Component damage can occur. Use only a damp or wet cloth to wipe the surface clean after scraping.



Caution!

Before any cleaning is done remove the batteries fuse.

5.3 Battery

The batteries are maintenance-free, but have a limited life span of 1-3 years. Battery life depends on the number of operations per week and the length of the season. The batteries should only be replaced by a service dealer.

Important! Do not place used batteries in your household trash. Batteries must be collected, recycled, or disposed of in an environmentally sound manner. Return the old batteries to an approved sealed lead (acid) battery recycler.

5.4 Base Station

Keep the Base Station entrance and area clean from leaves, sticks and twigs and any other debris that may tend to collect in these areas. Do not spray a water hose directly onto or into the Base Station. Use a damp rag and brush to clean the outer surface.

Treat any insect mounds, which may appear with a locally recommended insecticide. In the event of damage to any part of the power cord, stop use of the Base Station, disconnect the power supply and replace the power cord.

5.5 Replacing the Blade

The blade replacement is a very easy operation to perform; follow the instructions in figure 5.1 below.

The cutting blade of the Robomow should be examined for damage between operations. Only use sharp blade.

Replace blade at least once per season or after 200 hours of operation, the first to come. It is recommended to replace the blade for best performance. Machine sharpening is not recommended, as a good balance cannot be achieved after machine sharpening.

Robomow has an automatic reminder to replace the blade after every 200 hours of operation. **'Replace blade – every 200 hours'** message appears and pressing the **'GO'** button will clear the message and enables the operation of Robomow.

Whenever replacing the blade, it is recommended to restart the counter of the blade replacement reminder by choosing the **'Blade replaced'** option under the **'Settings'** menu and pressing the **'GO'** button again to clear the reminder.

Caution! To prevent the risk of serious injury, always remove the battery fuse when replacing the blade. For your safety, always wear heavy work gloves when working with or around the cutting blade.



1



2

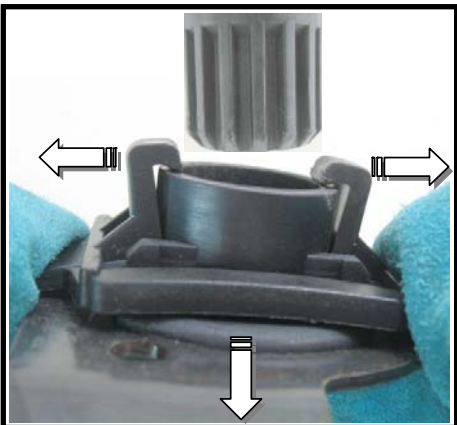

3

Blade replacement instructions

1. Remove the battery fuse;
2. Wear heavy work gloves;
3. Place Robomow on its rear side vertically, lay against a wall or turn it upside down on a soft surface;
4. To remove blade, using both hands, squeeze the plastic lock tabs at the base of the blade (step 1);

Squeeze the plastic locks tabs in the arrow direction as shown in step 2.

5. Then pull blade assembly off, away from mower (step 3);
6. Holding the replacement blade by its base, push until it is locked into place. You will hear a click when it locks. If you do not hear a click, remove blade, and repeat the procedure.

Figure 5.1
Blade replacement

5.6 Splicing the Perimeter Wire

If the perimeter wire needs to be spliced: Use the connectors supplied in the box, as shown in figure 5.2. It is waterproof and gives a reliable electrical connection.

Figure 5.2
Wires splicing

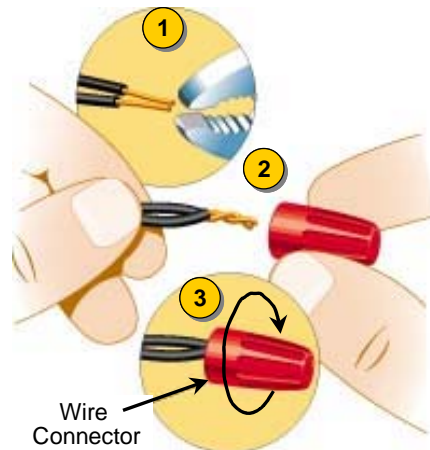

1. Strip 1cm (0.5 inch) of each wire ends together and twist the stripped ends together using pliers.
2. Insert the twisted wires into the splicing connector.
3. Screw the wire connector on the twisted wires; make sure is tight.

IMPORTANT INFORMATION!

Twisted cables, or a screw terminal, insulated with insulation tape is not a satisfactory splice. Soil moisture will cause the conductors to oxidize and after a while result in broken circuit.

5.7 Winter Storage

Robomow

Remove the battery fuse and clean the Robomow (refer to sections 5.2). Store Robomow indoors in a clean a dry place, standing on its wheels; confirm the area around the bumper is free.

Insert the battery fuse and connect the winter charger to the mains supply (figure 5.3) **for the entire period in which Robomow will not be operating**; confirm 'Charging' is displayed and 'Ready – keep charging' when the battery is fully charged.



Figure 5.3
Winter charging

The charging system and battery are designed such that they can remain plugged in at all times of non-use without concern to over charging, over heating or damaging the battery.

Base Station / Perimeter Switch

It is recommended to remove the **Base Station for the winter period:**

- Disconnect the power supply from the mains power;
- Open the Base Station / Perimeter Switch cover;
- Disconnect all connectors from the board;
- You can now remove the Base Station cover/ Perimeter Switch and place it in dry storage;
- It is recommended to store the power supply in a dry storage; if not possible, protect the cable end from moisture to prevent corrosion while not connected to the Base Station.
- Disconnect the green plot connector (keep it connected on the board for the next season) from the perimeter wire ends and protect it from moisture to prevent corrosion of the wires while not connected to the Base Station; You may place the Friendly Robotics wire nut connector onto both wire ends for protection in the winter.
- Protect the remaining connector using the black rubber cover.

After Winter Storage

- Confirm that all connections, charging pins and wire ends are clean prior the first operation; if required, clean the contacts with a small piece of fine sandpaper, 200 grit or higher or using steel wool of '00' or higher grade.
- Place the Base Station in its place and connect all cables to the board;
- Confirm that Robomow displays the correct time and date.

5.8 Batteries Replacement

WARNING! Follow the instructions below.

Complete replacement of one battery before starting to replace the second battery.

Replacing the batteries:

- Lift the bumper and remove the batteries fuse;
- Remove the cutting height adjustment knob by lifting it upwards (figure 5.4)
- Unscrew the five nuts manually at the rear side of the Chassis cover (figure 5.5). If you find it difficult use a wide flat screwdriver;
- Lift the rear side of the cover (see figure 5.6) and disconnect only the two cables from the left battery (figure 5.7);
- Place the new battery and connect the cables to the battery tabs when the red and the black cables are fitted to the color on the battery;
- Disconnect the cables from the right battery;
- Place the new battery and slightly crimp the battery connectors with plyers, so that they fit tightly on the battery tabs.
- Connect the cables to the battery tabs respectively by color;
- Place the cover back in its position and screw the five nuts manually, confirm they are tight enough;
- Insert the batteries fuse and confirm the Robomow wakes up.

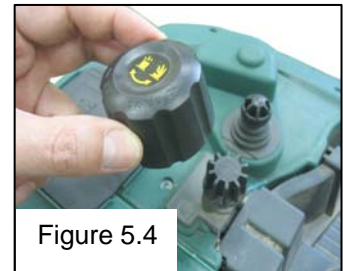

Figure 5.4

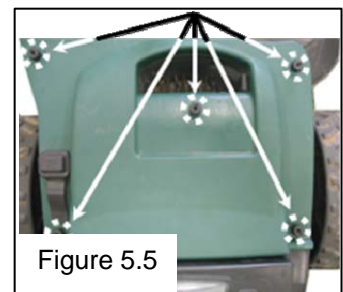

Figure 5.5



Figure 5.6

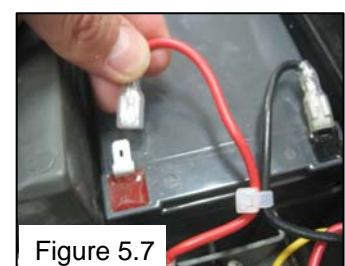

Figure 5.7

Chapter 6 - Specifications

Dimensions

64cm (25 inches) Length x 52cm (20 inches) Width x 30cm (12 inches) Height

Weight

17.6kg (38.8 lb)

Noise Level

Measured sound level: 77.2 dB

Guaranteed sound level: 80 dB

Mowing System

Cuts 1cm (0.4in) outside the wheels

Mowing width - 20cm (8 inches)

Cutting height – 20-80mm (0.8-3.2 inches)

Blade motor RPM – 5800

Theft Guard Code

Fill in the four-digit code you have selected for the Theft Guard system as a safe record in the event you forget the code selected.

Robomow Serial Number

Year of Manufacture

The decal below is found on the left side of the mower's base.

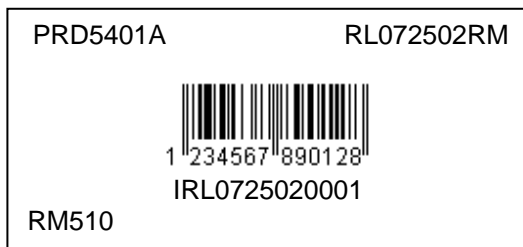

The first 2 digits represent the year of manufactured.
i.e. the label above belongs to a Robomow which was produced in 2007.

Chapter 7 - Accessories



Blade

Keep a spare blade on hand. Sharp blade is important for safety and good cutting performance.



Peg Pack (50)

For larger lawns and additional zones.



Perimeter Wire

For larger lawns and additional zones.



Perimeter Switch

Convenience of having a switch for each zone and not moving one switch from zone to zone. (operated by electricity)



Batteries Pack for RM Perimeter Switch

Preferable for areas where electricity is not available or not close enough to the Perimeter Switch.



Remote Control

for convenient transport of Robomow between plots, as well as mowing very narrow areas manually.



Wire connector

Used for repairing or splicing wires (as needed).



Plot connector

Used for connecting the completed perimeter wire set-up to the perimeter switch



2 x 12 AH Batteries

Weak batteries? No need to send Robomow to your service provider. They can easily be replaced by the user.

Tips for maintaining your lawn

Robomow® - Lawn care has never been so easy

Best time to mow

Mow your lawn when the grass is dry. This prevents the clippings from clumping and leaving piles on the lawn. Mow it late in the day rather than during the heat of the day.

Mowing frequency

Mow often, producing short, small clippings. During the active growing season the mowing frequency should be increased to once every 3-5 days, before the grass is too long. Short clippings decompose quickly and will not cover the grass surface. If the grass gets too high, raise the cutting height, mow, then gradually lower it over several mowings.

Cutting Height

Follow the "1/3 rule:" mow no more than 1/3 of the length of the grass. Proper mowing will produce short clippings that will not cover up the grass surface. You may have to cut the lawn more frequently, or double cut, when the lawn is growing fast, such as in the spring.

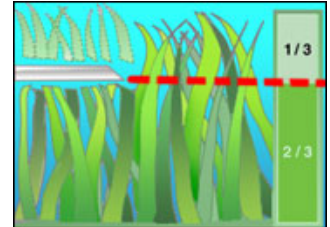

Water

Grasscycling reduces the amount of water needed by lawns since the clippings are about 80 - 85% water. Grasscycling slows evaporation losses from the soil surface, and conserves water. Most lawns need less water when Grasscycling.

Watering

Water your lawn between 4 a.m. and 8 a.m. in the morning, so water has time to soak into the soil before the heat of the sun causes evaporation.

Your lawn needs 1 to 1-1/2" (3-4cm) of water weekly. Deep watering allows grass to develop a deep root system, enabling the lawn to resist disease and drought.

Do not over water

Too much water is not only wasteful but can also increase turf growth, which requires more frequent mowing. Let the soil partially dry out between watering. Water when the top two inches of soil have dried out. Use an object such as a screwdriver to probe your soil and measure the depth of the moisture.

Fertilization

Grasscycling reduces the amount of lawn fertilizer needed because the clippings provide about 1/4 of a lawn's annual needs.

Blade

Keep your mower blade sharp. Sharp blade provides a clean, safe and efficient cut. Dull mower blade will tear and shred the tips of the grass, which can provide an entry point for disease organisms and weaken the grass plant. It is recommended to replace Robomow blade once a year.

Thatch

Clippings and thatch are simply not connected. As mentioned previously, grass clippings are approximately 80-85 percent water with only small amounts of lignin, and decompose rapidly.

When we stop and think about it, golf courses, sports fields, and parks have been mowing grass for years and recycling with no grass catchers.

A small amount of thatch (approximately 1/2 inch) is actually beneficial to a lawn. Grass clippings protect your lawn's root system from heat and water loss.

Robomow®

RM Series Limited Warranty

Friendly Robotics warrants to the original purchaser that the RM series 'Product' is free from defects in materials and workmanship when used under normal residential* purposes for a period of 24 months, 12 months for the batteries, beginning from the date of purchase. Product accessories, including replacement parts are warranted for a period of 6 months from the date of purchase. This warranty provides for the cost of parts and labor to repair covered defects when performed by an authorized Friendly Robotics service and warranty facility. A valid proof of purchase is required for warranty repairs.

The limited warranty does not cover transportation costs of any kind. The owner bears all responsibility for transportation costs to an authorized Friendly Robotics service and warranty facility.

*Normal residential purposes are defined as use of the product on the same lot as your primary home. Use at more than one location is considered commercial use, and this warranty would not apply.

Items and Conditions Not Covered

This express warranty does not cover the following:

- Cost of regular maintenance service parts or procedures, such as blade or blade sharpening.
- Any product or part that has been altered, misused, abused or requires replacement or repair due to accidents or lack of proper maintenance.
- Normal wear and tear, including fading of paint or plastic parts.
- Cost of installation or reinstallation, removal of installation or any costs or damages associated with improper installation or use of product.
- Any product that has been opened, repaired, modified or altered by anyone other than a Friendly Robotics authorized repair facility.
- Repairs necessary due to improper battery care and/or improper charging process such as charging in wet conditions, electrical supply irregularities, or failure to properly prepare the mower or battery prior to any period of non-use.
- Repairs necessary due to water damage, other than incidental rain exposure, repairs due to lighting or other acts of God.

Instructions for Obtaining Warranty Service

Should you feel your Friendly Robotics product contains a defect in materials or workmanship, contact the retailer who sold you the product.

Owner Responsibilities

You must maintain and care for your Friendly Robotics product by following the maintenance and care procedures described in the owner/operator manual. Routine maintenance, whether performed by a service provider or by you, is at your expense.

General Conditions

Repair by an authorized Friendly Robotics service and warranty repair facility is your sole remedy under this warranty. There is no other express or implied warranty. All implied warranties of merchantability and fitness for use are limited to the duration of this express warranty. Friendly Robotics is not liable for indirect, incidental or consequential damages in connection with the use of the Friendly Robotics Product covered by this warranty, including any cost or expense of providing substitute equipment or service during reasonable periods of malfunction or non-use pending completion of repairs under this warranty. Some states do not allow exclusions of incidental or consequential damages, or limitations on how long an implied warranty lasts, so the above exclusion and limitations may not apply to you. This warranty gives you specific legal rights, and you may also have other rights, which vary from state to state.

Always follow the safety instructions specified in this Manual

Robomow®

EU Declaration of Conformity

Manufacturer: F. Robotics Acquisitions Ltd.

Hatzabar St., Industrial Zone

P.O.Box 1412 Pardesiya,

42815 Israel

The products covered by this Declaration

24 Volt Battery operated Automatic Lawn Mower model RM200 (with Perimeter Switch)

24 Volt Battery operated Automatic Lawn Mower model RM510 (with Base Station)

F. Robotics Acquisitions Ltd. declares under sole responsibility that the products identified above conforms with the protection requirements of the EMC directive and with the principal elements of the safety objectives of the Low Voltage Equipment directive, and that the following standards have been applied:

- **EMC**

- Robomow (Tested according to EN 55014-1:2006 & EN 55014-2:1997 + A1:2001)

- Base Station (Tested according to: EN 55024:98 + A1:2001 + A2:2003 & EN 55022:1998 + A1:2000+A2:2003)

- **Electrical Safety**

BS EN 60335-1:2002 *AMD1 15172, 2002 *AMD2 15626, 2005 *AMD4 15051, 2004 *AMD5 15536, 2005 *AMD6 16671, 2007

BS EN 50338: 2006 AMD1 16778, 2006

- **Machinery Directive**

Directive 2006/42/EC

Safety of Machinery - Risk Assessment ISO 14121-1/2

- **Noise Directive**

- To BS EN ISO 3744: 1995 and *ISO 11094: 1991. With reference to Outdoor noise directive 2000/14/EC: Amended by directive 2005/88/EC and the corrigenda table 1. Article 12: Test code of Annex III Part B Item 32.

Sound level

Measured sound power level: LwA =77.2dB

Guaranteed sound power level: LwA =80dB

- **EMF**

BS EN 50366: 2003 amd1 16426, 2006

| EMC Competent Body | All Others Directives Competent Body |
|--|--|
| QualiTech 30,Hasivim Street P.O. Box 3083 Petah Tikva 49130 Israel | SGS UNITED KINGDOM LIMITED Rossmore Business Park ELLESMERE PORT CH65 3EN South Wirral Cheshire United Kingdom |

The technical documentation kept by Mr. Dedy Gur, QA Director. Address: Hatzabar St., Industrial Zone P.O.Box 1412 Pardesiya, 42815 Israel. And Mr. Lennert van der Pols Friendly Robotics BV. Address: Eikenstraat 15 B 1B2840 Reet, Netherlands.

I hereby declare that the above product conforms to the requirements as specified above.

Shai Abramson – Senior VP R&D



F. Robotics Acquisitions Ltd.

1 October 2011

EC DECLARATION OF CONFORMITY*) (Noise Level)

F. Robotics Acquisition Ltd. hereby certifies that equipment described below

0.1. Type: 24 Volt Battery operated Automatic Lawn Mower

0.2. Make (Trade name): ROBOMOW

0.2.1. Model/Type: RM200 (with Perimeter Switch)
RM510 (with Base Station)

0.3. Manufactured by: Name: F. Robotics Acquisitions Ltd.
Address: Hatzabar St., Industrial Zone P.O.Box 1412 Pardesiya, 42815 Israel

0.4. Person who keeps the technical documentation:
Name: Mr. Dedy Gur, QA director.
Address: Hatzabar St., Industrial Zone P.O.Box 1412 Pardesiya, 42815 Israel

0.5 Notified body: SGS UNITED KINGDOM LIMITED
Rossmore Business Park ELLESMERE PORT
CH65 3EN South Wirral Cheshire United Kingdom
SGS Reference: ELS111832/4/R/SW/07

0.6 Conformity assessment procedure (Test Specification):
To BS EN ISO 3744: 1995 and *ISO 11094: 1991.
With reference to Outdoor noise directive 2000/14/EC: Amended by directive 2005/88/EC and the corrigenda table 1. Article 12: Test code of Annex III Part B Item 32.

0.7 Date:6th May 2008 **0.8 Place:** SGS UNITED KINGDOM LIMITED

Conforms to the requirements of Directive 2000/14/EC and to the requirements of the Directives 2005/88/EC and the corrigenda table 1. Article 12: Test code of Annex III Part B Item 32:

- Machinery Directive
- Low Voltage Directive
- Directive on Electromagnetic Compatibility

Signature (Full name and position ^{}):** Shai Abramson – Senior VP R&D



Brief description of equipment: 24 Volt Battery operated Automatic Lawn Mower

1. **Sound level**
- 1.2. **Measured sound power level:**.....LwA =77.2 dB
- 1.3. **Guaranteed sound power level:**.....LwA =80 dB

2. **Sound related parameter:**
Cutting Width: 19.5 cm

⁾This declaration must be made in the same language as the original instructions, and either typewritten or printed. A translation in the language (s) of the user country must also be provided. These translations are subject to the same conditions as the original instructions.

^{*)} e.g. a function empowering the signatory to sign on behalf of the manufacturer (if the manufacturer is a natural person, this is the manufacturer or his legal representative, and in the case of a legal person or association having no legal personality, it is the person authorized to represent/manage him by law or by his rules or articles of association).

^{***)}For combustion-engine driven equipment it should be the nominal engine speed at which noise measurements are recorded. For chain saws: this should be the nominal engine speed under full load conditions at which noise measurements are recorded.

Robomow®

To register your product on-line, go to

<http://robomow.com/register>

Robomow® Hotline

AT. 0664/180.88.09
BE. 070.660.124*
CH. 0900.888.101***
CZ. 800.909.898
DE. 09005.7626669**
DK. 7025.2303
FR. 0892.230.199*
LU. 0900.4300.4090*
NL. 0900.762.6669*
NO. 4000.7719
SE. 0771.895.895



* Max €0.35 p/m.

** Werktags von 9-12 und 13-16 Uhr 0,59€ pro Minute aus dem deutschen Festnetz. Die ersten zwei Minuten sind kostenfrei. Die Mobilfunkkosten können abweichen.

*** 0-5 Min.= CHF 0.08/Min. ab/à partir de 6.Min.= CHF 1.40/Min.

www.robomow.com

www.robomow.eu